

Технические характеристики

По вопросам продаж и поддержки обращайтесь:

Алматы (7273)495-231	Казань (843)206-01-48	Новокузнецк (3843)20-46-81	Смоленск (4812)29-41-54
Архангельск (8182)63-90-72	Калининград (4012)72-03-81	Новосибирск (383)227-86-73	Сочи (862)225-72-31
Астрахань (8512)99-46-04	Калуга (4842)92-23-67	Омск (3812)21-46-40	Ставрополь (8652)20-65-13
Барнаул (3852)73-04-60	Кемерово (3842)65-04-62	Орел (4862)44-53-42	Сургут (3462)77-98-35
Белгород (4722)40-23-64	Киров (8332)68-02-04	Оренбург (3532)37-68-04	Тверь (4822)63-31-35
Брянск (4832)59-03-52	Краснодар (861)203-40-90	Пенза (8412)22-31-16	Томск (3822)98-41-53
Владивосток (423)249-28-31	Красноярск (391)204-63-61	Пермь (342)205-81-47	Тула (4872)74-02-29
Волгоград (844)278-03-48	Курск (4712)77-13-04	Ростов-на-Дону (863)308-18-15	Тюмень (3452)66-21-18
Вологда (8172)26-41-59	Липецк (4742)52-20-81	Рязань (4912)46-61-64	Ульяновск (8422)24-23-59
Воронеж (473)204-51-73	Магнитогорск (3519)55-03-13	Самара (846)206-03-16	Уфа (347)229-48-12
Екатеринбург (343)384-55-89	Москва (495)268-04-70	Санкт-Петербург (812)309-46-40	Хабаровск (4212)92-98-04
Иваново (4932)77-34-06	Мурманск (8152)59-64-93	Саратов (845)249-38-78	Челябинск (351)202-03-61
Ижевск (3412)26-03-58	Набережные Челны (8552)20-53-41	Севастополь (8692)22-31-93	Череповец (8202)49-02-64
Иркутск (395)279-98-46	Нижний Новгород (831)429-08-12	Симферополь (3652)67-13-56	Ярославль (4852)69-52-93
Россия (495)268-04-70	Киргизия (996)312-96-26-47	Казахстан (7172)727-132	

01

Lever Grease Guns Heavy Duty

Top of the line grease gun for heavy industrial applications

Built Tough

- Barrel with 0.049" (1.2 mm) wall thickness
- Heavy duty follower spring
- High tolerance CNC machined, aluminium die cast head
- Rolled threads for quick & easy re-loading

Variable Stroke

Convenient greasing even in tight spaces with limited movement of handle



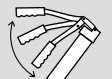

Available in 2 choices

- 6" (150 mm) steel extension & coupler
- 12" (300 mm) × 0.33" (8.5 mm) flexible hose & coupler

FEATURES

DEVELOPS	
	UPTO 10,000 PSI (690 BAR)
DELIVERS	
UPTO 1 GM / STROKE (1 OZ. / 28 STROKES)	
VARIABLE STROKE	
	

FILLING OPTIONS

SUCTION FILL 	BULK FILL 
CARTRIDGE LOADING 	FILLER PUMP LOADING 



Aluminium die cast head with bulk loader and air bleeder valve

G1-HD**G4-HD****G10-HD**

VARIANTS

G1-HD

∅
2-1/4"
(57.15 MM)

Use with 14 oz. (400 gms)
grease cartridge/500cc bulk
grease

G4-HD

∅
63.5 MM

Use with 450gms grease
cartridge popular in Australia
& New Zealand

G10-HD

∅
2-1/4"
(57.15 MM)

High capacity gun
Use with 14 oz. (400 gm)
grease cartridge/
24 oz. (750cc) bulk grease

ORDERING INFORMATION

CAT NR.	ORD NR.	CAT NR.	ORD NR.	CARTRIDGE CAPACITY		BULK CAPACITY	THREADS	BOX QTY.
				(OZ.)	(GMS)	(CM ³)		
6" (150 MM) STEEL EXTENSION & COUPLER		12" (300 MM) FLEXIBLE HOSE & COUPLER						
* G1R/HD/B	42700	G1F/HD/B	42720	14	400	500	1/8" BSPT	16
* G1R/HD/M	42701	G1F/HD/M	42721	14	400	500	M10 × 1	16
* G1R/HD/N	42702	G1F/HD/N	42722	14	400	500	1/8" NPT	16
* G4R/HD/B	42780	G4F/HD/B	42785	-	450	650	1/8" BSPT	16
G10R/HD/B	42750	G10F/HD/B	42760	14	400	750	1/8" BSPT	10
G10R/HD/M	42751	G10F/HD/M	42761	14	400	750	M10 × 1	10
G10R/HD/N	42752	G10F/HD/N	42762	14	400	750	1/8" NPT	10

* Best Seller

NEW!

Patented design: Switch over from High Pressure to High Volume with the simple slide of a button

Built Tough

- Barrel with 0.049”(1.2mm) wall thickness
- Heavy duty follower spring
- High tolerance CNC machined Aluminium die cast head fitted with bulk loader that doubles as an air bleeder
- Non-slip textured powder coated finish for extended working life

Dual Operating Modes

Choose between High Pressure and High Volume setting by simple slide of a button

A. High Pressure Setting

Gun achieves max. working pressure in a few strokes making it useful to open jammed/ clogged fittings conveniently even in very cold weather conditions

B. High Volume Setting

With an output upto 3X of a regular Grease Gun, this gun reduces greasing time saving time and cost.

Dual Discharge Ports

Front and top port for convenient greasing on inaccessible fittings

Choice of

1. 6” (150mm) steel extension & coupler
2. 12”(300mm) x 0.43”(11 mm) high pressure hose and coupler

FILLING OPTIONS

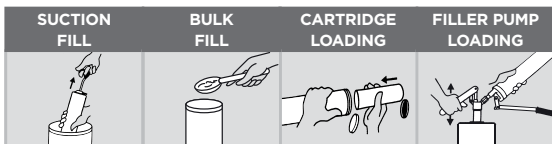

ORDERING INFORMATION

CAT NR.	ORD NR.	CAT NR.	ORD NR.	THREADS
STEEL EXTENSION & COUPLER		FLEXIBLE HOSE & COUPLER		
G200R/B	42340	G200F-HP/B	42350	1/8” BSPT
G200R/M	42341	G200F-HP/M	42351	M10 x 1
G200R/N	42342	G200F-HP/N	42352	1/8” NPT



HIGH PRESSURE MODE

MAXIMUM PRESSURE

12,000 PSI (830 BAR)

DELIVERS

UPTO 0.6 GM / STROKE (1 OZ/ 47 STROKES)

HIGH VOLUME MODE

DELIVERS

UPTO 3.2 GM / STROKE (1 OZ/ 10 STROKES)

MAXIMUM PRESSURE

2,000 PSI (130 BAR)



NEW!

The High Output Greasing Solution

For greasing applications requiring voluminous and frequent greasing

Built Tough

- Dual piston design for 3X output of grease per stroke
- Barrel with 0.049" (1.2 mm) wall thickness
- Heavy duty follower spring
- High tolerance CNC machined Aluminium die-cast head with air release valve
- Rolled threads for quick and easy reloading

Reduce Greasing Time To One-Third

Dual piston mechanism results in triple output per stroke reducing greasing time to one-third. A time and cost saving feature especially on agricultural and construction machinery where volume and frequency of greasing is high

No Loss of Prime

Dual inlet of grease ensures that gun does not lose prime

Convenience of Use

Even in extreme cold weather conditions

Available in 2 Choices

- 6" (150 mm) bent steel extension and coupler
- 12" (300 mm) x 0.33" (8.5 mm) flexible hose & coupler

Air Release Valve

Dual Inlet

Dual Piston Mechanism

Heavy Duty Lever Handle



**3X
ADVANTAGE**
Reduce Greasing Time To One-Third!

FEATURES

DELIVERS	MAXIMUM PRESSURE
<p>UPTO 2.4 GM / STROKE (1 OZ / 12 STROKES)</p>	 <p>6,000 PSI (413 BAR)</p>

FILLING OPTIONS

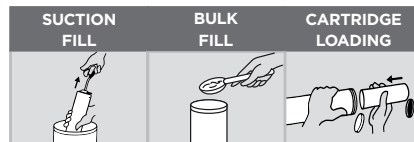

ORDERING INFORMATION

CAT NR.	ORD NR.	CAT NR.	ORD NR.	CARTRIDGE CAPACITY		BULK CAPACITY	THREADS
				(OZ)	(GMS)		
STEEL EXTENSION & COUPLER		FLEXIBLE HOSE & COUPLER					
G2R/B	42630	G2F/B	42640	14	400	500	1/8" BSPT
G2R/M	42631	G2F/M	42641	14	400	500	M10 x 1
G2R/N	42632	G2F/N	42642	14	400	500	1/8" NPT

04

Supa-Lite Lever Grease Gun

G1HD-AL

"SUPA-LITE" lightweight aluminium grease guns

Designed for fatigue free & comfortable everyday greasing in automotive, fleet, industrial, farm & construction applications

Barrel made from lightweight yet strong aircraft grade 0.063" (1.6 mm) thick aluminium

Aluminium die cast head with bulk loader & air bleeder valve



Variable Stroke

Convenient greasing even in tight spaces with limited movement of handle



Available in 2 choices

- a. 6" (150 mm) steel extension & coupler
- b. 12" (300 mm) x 0.33" (8.5 mm) flexible hose & coupler

FEATURES

DEVELOPS	
	UPTO 10,000 PSI (690 BAR)
DELIVERS	
	UPTO 1 GM / STROKE (1 OZ. / 28 STROKES)
VARIABLE STROKE	
	

FILLING OPTIONS

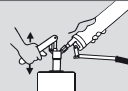
SUCTION FILL	BULK FILL
	
CARTRIDGE LOADING	FILLER PUMP LOADING
	



 **25% LIGHTER** THAN STEEL GUNS

ORDERING INFORMATION

CAT NR.	ORD NR.	CAT NR.	ORD NR.	CARTRIDGE CAPACITY		BULK CAPACITY (CM ³)	THREADS	BOX QTY.
				(OZ.)	(GMS)			
6" (150 MM) STEEL EXTENSION & COUPLER		12" (300 MM) FLEXIBLE HOSE & COUPLER						
G1R/HD/AL/BL/B	42723	G1F/HD/AL/BL/B	42726	14	400	500	1/8" BSPT	16
G1R/HD/AL/BL/M	42724	G1F/HD/AL/BL/M	42727	14	400	500	M10 x 1	16
G1R/HD/AL/BL/N	42725	G1F/HD/AL/BL/N	42728	14	400	500	1/8" NPT	16

Professional model - ideal for automotive applications

Built Tough

- Barrel with 0.049" (1.2 mm) wall thickness
- Heavy duty follower spring
- CNC machined aluminium die cast head
- Rolled threads for quick & easy reloading



Variable Stroke

Convenient greasing even in tight spaces with limited movement of handle



Available in 2 choices

- a. 6" (150 mm) steel extension & coupler
- b. 12" (300 mm) x 0.33" (8.5 mm) flexible hose & coupler

FEATURES

DEVELOPS	
	UPTO 8,000 PSI (550 BAR)
DELIVERS	
	UPTO 1 GM / STROKE (1 OZ. / 28 STROKES)
VARIABLE STROKE	
	

FILLING OPTIONS

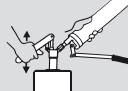
SUCTION FILL	BULK FILL
	
CARTRIDGE LOADING	FILLER PUMP LOADING
	



ORDERING INFORMATION

CAT NR.	ORD NR.	CAT NR.	ORD NR.	CARTRIDGE CAPACITY		BULK CAPACITY	THREADS	BOX QTY.
				(OZ.)	(GMS)			
6" (150 MM) STEEL EXTENSION & COUPLER		12" (300 MM) FLEXIBLE HOSE & COUPLER						
G8R/BL/B	42607	G8F/BL/B	42623	14	400	500	1/8" BSPT	16
G8R/BL/M	42608	★ G8F/BL/M	42624	14	400	500	M10 x 1	16
G8R/BL/N	42609	G8F/BL/N	42625	14	400	500	1/8" NPT	16

★ Best Seller

06
**Lever Grease Guns
Standard**

Hard working entry level grease gun, designed for general lubrication & daily maintenance jobs

Head with single vent hole fitted with a block nut

Air release achieved through half turn of head assembly



Available in 2 choices

- a. 6" (150 mm) steel extension & coupler
- b. 12" (300 mm) × 0.33" (8.5 mm) flexible hose & coupler

FEATURES

DEVELOPS	
	UPTO 6,000 PSI (413 BAR)
DELIVERS	
	UPTO 1 GM / STROKE (1 OZ. / 28 STROKES)

FILLING OPTIONS

SUCTION FILL 	BULK FILL 
CARTRIDGE LOADING 	

G1-STD**G1-DC****G23****VARIANTS****G1-STD**

∅
2-1/4"
(57.15 MM)

Powder coated steel head
Use with 14oz. (400 gm)
grease cartridge or 500cc
bulk grease

G1-DC

∅
2-1/4"
(57.15 MM)

Aluminium die cast head
Use with 14 oz. (400 gm)
grease cartridge or 500cc
bulk grease

G23

∅
2-1/4"
(57.15 MM)

Powder coated Aluminium
die cast head & heavy duty
lever handle
Use with 14 oz. (400 gms)
grease cartridge or 500 cc
bulk grease

ORDERING INFORMATION

CAT NR.	ORD NR.	CAT NR.	ORD NR.	CARTRIDGE CAPACITY		BULK CAPACITY	THREADS	BOX QTY.
				(OZ.)	(GMS)			
6" (150 MM) STEEL EXTENSION & COUPLER		12" (300 MM) FLEXIBLE HOSE & COUPLER						
STEEL HEAD								
G1R/STD/B	42400	G1F/STD/B	42420	14	400	500	1/8" BSPT	16
G1R/STD/M	42401	G1F/STD/M	42421	14	400	500	M10 × 1	16
* G1R/STD/N	42402	G1F/STD/N	42422	14	400	500	1/8" NPT	16
ALUMINIUM DIE CAST HEAD								
G1R/STD/DC/B	42450	G1F/STD/DC/B	42470	14	400	500	1/8" BSPT	16
* G1R/STD/DC/M	42451	* G1F/STD/DC/M	42471	14	400	500	M10 × 1	16
* G1R/STD/DC/N	42452	G1F/STD/DC/N	42472	14	400	500	1/8" NPT	16
POWDER COATED ALUMINIUM DIE CAST HEAD								
G23R/B	42430	G23F/B	42440	14	400	500	1/8" BSPT	10
G23R/M	42431	G23F/M	42441	14	400	500	M10 × 1	10
* G23R/N	42432	G23F/N	42442	14	400	500	1/8" NPT	10

* Best Seller

07

Lever Grease Guns Super Value

Most popular grease gun for general purpose lubrication in automotive, agricultural & industrial applications

Drop-resistant steel head fitted with bulk loader valve

Air release either through the bulk loader or half turn of head assembly





Available in 2 choices

- a. 6" (150 mm) steel extension & coupler
- b. 12" (300 mm) x 0.33" (8.5mm) flexible hose & coupler

FEATURES

DEVELOPS	
	UPTO 6,000 PSI (413 BAR)
DELIVERS	
UPTO 1 GM / STROKE (1 OZ. / 28 STROKES)	

FILLING OPTIONS

SUCTION FILL	BULK FILL
	
CARTRIDGE LOADING	FILLER PUMP LOADING
	



Drop-resistant steel head with bulk loader valve

Ergonomic rubber grip

'V Type' drop resistant plunger rod handle

G1**G10****G4****G11**

VARIANTS

G1

∅
2-1/4"
(57.15 MM)

Use with 14 oz. (400 gms)
grease cartridge/500cc bulk
grease

G4

∅
63.5 MM

Use with 450 gms grease
cartridge popular in Australia
& New Zealand

G10

∅
2-1/4"
(57.15 MM)

High capacity gun
Use with 14 oz. (400 gm)
grease cartridge / 24 oz.
(750cc) bulk grease

G11

∅
2-1/4"
(57.15 MM)

**Extra long & very high
capacity grease gun**
Use with 14 oz. (400 gms)
grease cartridge /
35 oz. (1000 cc bulk grease)

ORDERING INFORMATION

CAT NR.	ORD NR.	CAT NR.	ORD NR.	CARTRIDGE CAPACITY		BULK CAPACITY	THREADS	BOX QTY.
				(OZ.)	(GMS)	(CM ³)		
6" (150 MM) STEEL EXTENSION & COUPLER		12" (300 MM) FLEXIBLE HOSE & COUPLER						
* G1R/SLV/B	42500	G1F/SLV/B	42520	14	400	500	1/8" BSPT	16
* G1R/SLV/M	42501	G1F/SLV/M	42521	14	400	500	M10 × 1	16
G1R/SLV/N	42502	G1F/SLV/N	42522	14	400	500	1/8" NPT	16
* G4R/B	42580	G4F/B	42585	-	450	650	1/8" BSPT	16
G10R/B	42590	G10F/B	42595	14	400	750	1/8" BSPT	10
* G10R/M	42591	G10F/M	42596	14	400	750	M10 × 1	10
G11R/B	42560	G11F/B	42565	14	400	1000	1/8" BSPT	10
G11R/M	42561	G11F/M	42566	14	400	1000	M10 × 1	10

* Best Seller

Ideal combination of superior quality and value price

Aluminium die cast head fitted with automatic air bleeder valve

Black powder coated finish



Available in 2 choices

- a. 6" (150 mm) steel extension & coupler
- b. 12" (300 mm) × 0.33" (8.5 mm) flexible hose & coupler

FEATURES

DEVELOPS	
	UPTO 6,000 PSI (413 BAR)
DELIVERS	
	UPTO 1 GM / STROKE (1 OZ. / 28 STROKES)

FILLING OPTIONS

SUCTION FILL	BULK FILL
	
CARTRIDGE LOADING	
	



ORDERING INFORMATION

CAT NR.	ORD NR.	CAT NR.	ORD NR.	CARTRIDGE CAPACITY		BULK CAPACITY (CM ³)	THREADS	BOX QTY.
				(OZ.)	(GMS)			
6" (150 MM) STEEL EXTENSION & COUPLER		12" (300 MM) FLEXIBLE HOSE & COUPLER						
★ VIR/BL/B	42912	V1F/BL/B	42926	14	400	500	1/8" BSPT	16
★ VIR/BL/M	42913	V1F/BL/M	42927	14	400	500	M10 × 1	16
VIR/BL/N	42914	V1F/BL/N	42928	14	400	500	1/8" NPT	16

★ Best Seller

Professional Lever Gun for use in construction, agricultural and industrial applications

Built Tough

- Barrel with 0.049" (1.2 mm) wall thickness
- High tolerance CNC machined head with threaded port for use with JIABARA style grease cartridges popular in Japan
- Heavy duty follower spring
- Chain style follower handle
- Large rolled threads for fast & easy reloading



Complete with

6" (150 mm) steel extension & coupler

FEATURES

DEVELOPS	
	UPTO 8,000 PSI (550 BAR)
DELIVERS	
	UPTO 0.90 GMS / STROKE

FILLING OPTIONS

SUCTION FILL	BULK FILL	CARTRIDGE LOADING
		



JIABARA grease cartridge (not included)



Aluminium die-cast head with threaded port for use with JIABARA style grease cartridges popular in Japan

Non-slip textured powder coated finish

Ø
59.7 MM

Heavy duty chain for operating rubber follower

ORDERING INFORMATION

CAT NR.	ORD NR.	CARTRIDGE CAPACITY		BULK CAPACITY	THREADS	BOX QTY.
		(OZ.)	(GMS)			
G81R/B	42790	14	400	600	1/8" BSPT	10



Heavy duty Oil Gun

Handles flow-able greases and light oils without any leakage and mess. Also useful for pumping glue in water proofing and other construction applications

Built Tough

- High tolerance aluminium die cast head
- High quality CDW barrel, machined seam for leak proof performance
- Follower designed to work both with oils and grease

Variable Stroke

For convenient usage even in tight spaces with limited movement of handle

Available in 2 choices

- 6" (150 mm) steel extension & coupler
- 12" (300 mm) × 0.33" (8.5 mm) flexible hose & coupler

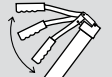

FEATURES

DEVELOPS	
	UPTO 10,000 PSI (690 BAR)
DELIVERS	
	UPTO 1 GM / STROKE (1 OZ. / 28 STROKES)
VARIABLE STROKE	
	

FILLING OPTIONS

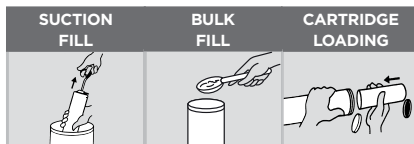

ORDERING INFORMATION

CAT NR.	ORD NR.	CAT NR.	ORD NR.	CARTRIDGE CAPACITY		BULK CAPACITY	THREADS	BOX QTY.
				(OZ.)	(GMS)			
6" (150 MM) STEEL EXTENSION & COUPLER		12" (300 MM) FLEXIBLE HOSE & COUPLER						
G19R/B	42740	G19F/B	42745	14	400	500	1/8" BSPT	12
G19R/M	42741	G19F/M	42746	14	400	500	M10 × 1	12
G19R/N	42742	G19F/N	42747	14	400	500	1/8" NPT	12

Unique concept & design for quick and clear lubricant identification eliminating the risk of cross contamination or mixing of incompatible lubricants

Tough, impact and drop resistant polycarbonate tube with aluminium die cast adaptors

High tolerance aluminium die cast head with bulk loader & air bleeder valve



Variable Stroke

Convenient greasing even in tight spaces with limited movement of handle

Complete with 6" (150 mm) steel extension & coupler

Barrel available as spare also

FEATURES

DEVELOPS	
	UPTO 10,000 PSI (690 BAR)
DELIVERS	
	UPTO 1 GM / STROKE (1 OZ. / 28 STROKES)
VARIABLE STROKE	
	



Quick lubricant identification eliminating the risk of mixing incompatible or unspecified lubricants



Clear Tube Barrel only

FILLING OPTIONS

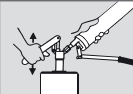
CARTRIDGE LOADING	FILLER PUMP LOADING
	

ORDERING INFORMATION

CAT NR.	ORD NR.	CARTRIDGE CAPACITY		BULK CAPACITY (CM ³)	THREADS	BOX QTY.
		(OZ.)	(GMS)			
GREASE GUN						
G1R/HD/B-CL	46900	14	400	500	1/8" BSPT	16
G1R/HD/M-CL	46901	14	400	500	M10 x 1	16
G1R/HD/N-CL	46902	14	400	500	1/8" NPT	16
G4R/HD/B-CL	46903	-	450	650	1/8" BSPT	16
BARREL ONLY						
BRL/G1-CL	46990	14 oz. (400 gms) replacement for clear tube barrel only			2.2806" x 16 UNF	20
BRL/G4-CL	46991	450 gms replacement for clear tube barrel only			2.5" x 16 UNF	20

WARNING

Designed for use with grease only: Do not use with: ESTER based Greases, Synthetic Greases such as Aeroshell 33 Grease, Aeroshell 7 Grease, Skydrol Products etc. These have an adverse effect on the clear polycarbonate tube & can cause fogging, cracking & fracturing of the tube.

12

SPIN-ON GREASE GUNS

G48

G48P

A new line of professional grade Spin-On Grease Guns for convenient, quicker & easier greasing. Available in Lever & Pistol versions



1 Screw-In

2 Spin-On

3 Get Going!

CONVENIENT & TIME SAVING

- Remove screw cap & screw-in the cartridge... Spin-on grease gun is ready to use
- No priming needed

EFFORTLESS

- Cartridge loading with one hand leaving the other hand free for other jobs

MONEY SAVING

- Easy to monitor available grease quantity in the cartridge
- Easily refillable cartridge - No need to buy a new cartridge every time

NO MESS/ NO WASTAGE

- Keeps grease off the users hands & clothes
- Complete quantity of grease in cartridge used up
- No wasted grease
- No cleanliness/safety hazards

Special spin-on grease gun for quick, effortless high pressure greasing applications

Spin-On cartridge works on special “vacuum technology” that ensures full utilization of grease in the cartridge and eliminates priming issues associated with conventional grease guns

Fast & easy reloading without unscrewing the head

No air pockets, hence no air bleeding required

Robust high tolerance aluminium die cast head

Minimal wearing parts give it a long life

Non slip Textured powder coated finish for extended service life, way more than zinc plated grease guns

Lever grease gun is available in 2 choices

- a. 6" (150 mm) steel extension & coupler
- b. 12" (300 mm) x 0.33" (8.5 mm) flexible hose & coupler

Pistol grease gun is available in 3 choices

- a. 4" (100 mm) steel extension & coupler
- b. 12" (300 mm) x 0.33" (8.5 mm) flexible hose & coupler
- c. 12" (300 mm) x 0.425" (11 mm) heavy duty hose & coupler



VARIANTS

LEVER GREASE GUNS - G48		PISTOL GREASE GUNS - G48P	
<p>DEVELOPS</p> <p>UPTO 6,000 PSI (413 BAR)</p>		<p>DEVELOPS</p> <p>UPTO 5,000 PSI (345 BAR)</p>	
<p>DELIVERS</p> <p>UPTO 0.9 GM/STROKE</p>		<p>DELIVERS</p> <p>UPTO 0.5 GM/STROKE</p>	

ORDERING INFORMATION

CAT NR.	ORD NR.	ACCESSORIES	THREADS	BOX QTY.
LEVER GREASE GUNS				
G48R/B	42791	6" (150 mm) steel extension & coupler	1/8" BSPT	20
G48R/M	42792	6" (150 mm) steel extension & coupler	M10x1	20
G48F/B	42797	12" (300 mm) x 0.33" (8.5 mm) flexible hose & coupler	1/8" BSPT	20
G48F/M	42794	12" (300 mm) x 0.33" (8.5 mm) flexible hose & coupler	M10x1	20
PISTOL GREASE GUNS				
G48PR/B	43160	4" (100 mm) steel extension & coupler	1/8" BSPT	20
G48PR/M	43161	4" (100 mm) steel extension & coupler	M10x1	20
G48PF/B	42798	12" (300 mm) x 0.33" (8.5 mm) flexible hose & coupler	1/8" BSPT	20
G48PF/M	43176	12" (300 mm) x 0.33" (8.5 mm) flexible hose & coupler	M10x1	20
G48PF-HP/B	43170	12" (300 mm) x 0.425" (11 mm) heavy duty hose & coupler	1/8" BSPT	20
G48PF-HP/M	43171	12" (300 mm) x 0.425" (11 mm) heavy duty hose & coupler	M10x1	20

Double Lever gun for quick and effortless high pressure greasing applications

Screw-in cartridge works on special 'Vacuum Technology' that ensures:

1. Full utilization of grease in the cartridge
2. Eliminates priming issues usually associated with conventional grease guns

Seal guards at both ends of the cartridge create vacuum that pulls out grease emptying the cartridge completely

Robust high tolerance aluminium die cast head
Minimal wearing parts give it a long life

No connections hence no potential leaks or contamination issues

Complete with
12" (300 mm) × 0.425" (11 mm)
heavy duty hose & coupler

FEATURES

DEVELOPS	
	UPTO 7,500 PSI (517 BAR)
DELIVERS	
	UPTO 0.8 GM / STROKE (1 OZ. / 35 STROKES)

FILLING OPTIONS

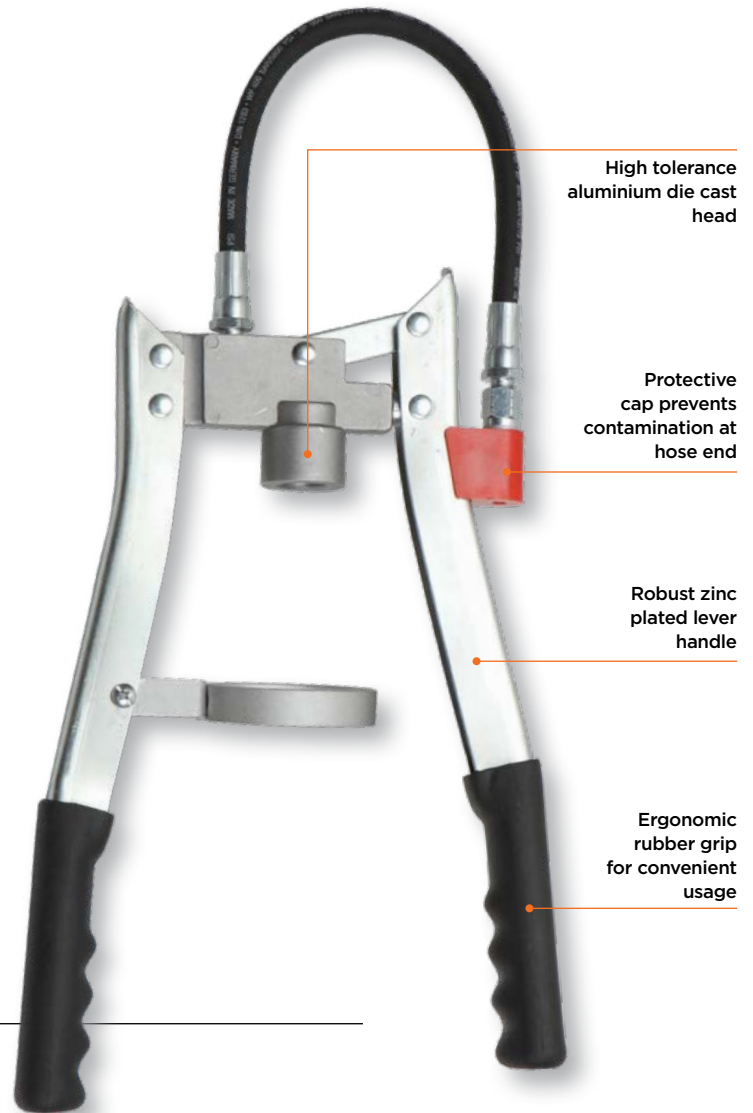
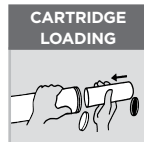

VARIANTS

<p>G83F-HP For use with F type threaded grease cartridges</p>	<p>G83F-HP/MTO For use with both F type and LS type threaded grease cartridges</p>
--	---

ORDERING INFORMATION

CAT NR.	ORD NR.	CARTRIDGE CAPACITY	THREADS	BOX QTY.
		(GMS)		
G83F-HP/B	42795	500	1/8" BSPT	10
G83F-HP/M	42796	500	M10 × 1	10
◆ G83F-HP/MTO/B	42799	400	1/8" BSPT	10

◆ New



NEW!

Patented design: Switch over from High Pressure to High Grease Volume with the simple slide of a button

Built Tough

- Barrel with 0.049”(1.2mm) wall thickness
- Heavy duty follower spring
- High tolerance CNC machined Aluminium die cast head fitted with bulk loader that doubles as an air bleeder
- Non-slip textured powder coated finish for extended working life

Dual Operating Modes

Choose between High Pressure and High Volume setting by simple slide of a button

A. High Pressure Setting

Gun achieves max. working pressure in a few strokes making it useful to open jammed/ clogged fittings conveniently even in very cold weather conditions

B. High Volume Setting

With an output upto 3X of a regular Grease Gun, this gun reduces greasing time saving time and cost.

Dual Discharge Ports

Front and top port for convenient greasing on inaccessible fittings

Choice of

1. 4” (100mm) steel extension & coupler
2. 18”(450mm) x 0.43” (11 mm) high pressure hose and coupler

FILLING OPTIONS

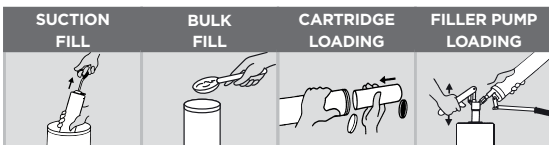

ORDERING INFORMATION

CAT NR.	ORD NR.	CAT NR.	ORD NR.	THREADS
STEEL EXTENSION & COUPLER		FLEXIBLE HOSE & COUPLER		
G500R/B	42360	G500F-HP18/B	42370	1/8” BSPT
G500R/M	42361	G500F-HP18/M	42371	M10 × 1
G500R/N	42362	G500F-HP18/N	42372	1/8” NPT



HIGH PRESSURE MODE



MAXIMUM PRESSURE

10,000 PSI (690 BAR)

DELIVERS

UPTO 0.4 GM / STROKE (1 OZ/ 70 STROKES)



HIGH VOLUME MODE



DELIVERS

UPTO 1.3 GM / STROKE (1 OZ/ 22 STROKES)

MAXIMUM PRESSURE

2,000 PSI (130 BAR)



Lifetime product: Ideal for frequent greasing applications

Patented feather touch design - maximum output with minimal effort

Variable Stroke

Unique variable stroke feature allows gun to reach increased pressure from short strokes and high greasing volumes from full strokes

Built Tough

- Barrel with 0.049" (1.2 mm) wall thickness
- Heavy duty follower spring
- High tolerance CNC machined, aluminium die cast head
- Rolled threads for quick & easy re-loading

Higher Output

Delivers upto 1-1/2 times more grease per stroke than other pistol grip guns

Higher Pressure

Develops upto 7500 PSI (517 BAR), not found in commonly sold pistol grip grease guns

Complete with

9" (255 mm) x 0.425" (11 mm) high pressure flexible hose & coupler

Aluminium die cast head with unique bulk loader which double as an air bleeder

One piece aluminium die cast head & fixed handle for extra strength & convenience in use





Ø
2-1/4"
(57.15 mm)

Non-slip textured finish

Lock Lever: Locks plunger rod at any position

FEATURES

DEVELOPS	
	UPTO 7,500 PSI (517 BAR)
DELIVERS	
	UPTO 0.68 GM / STROKE (1 OZ. / 40 STROKES)
VARIABLE STROKE	
	

ORDERING INFORMATION

CAT NR.	ORD NR.	CARTRIDGE CAPACITY		BULK CAPACITY (CM ³)	THREADS	BOX QTY.
		(OZ.)	(GMS)			
* G32F-HP9/B	43061	14	400	500	1/8" BSPT	16
G32F-HP9/M	43062	14	400	500	M10 x 1	16
* G32F-HP9/N	43063	14	400	500	1/8" NPT	16

* Best Seller

FILLING OPTIONS

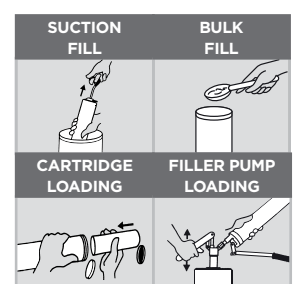

Most popular One Hand Operated Grease Gun

Designed for use in confined spaces where access to grease nipple is restricted

Built Tough

- Barrel with 0.049" (1.2 mm) wall thickness
- Heavy duty follower spring
- High tolerance CNC machined head
- Rolled threads for quick & easy re-loading

Super strong pistol grip handle designed to prevent 'pinching'

Available in 2 choices

- 4" (100 mm) steel extension & coupler
- 12" (300 mm) x 0.33" (8.5 mm) flexible hose & coupler



VARIANTS

G5

2-1/4"
(57.15 MM)

Use with 14 oz.
(400 gms) grease
cartridge/500cc
bulk fill

G4-PST

63.5 MM

Use with
450 gms grease
cartridge popular
in Australia & New
Zealand

G5-PRO

2-1/4"
(57.15 MM)

Professional Model:
Head fitted with bulk
loader & air bleeder
valve. Vinyl grip on
movable handle

Use with 14 oz.
(400 gms) grease
cartridge/500cc
bulk fill

FEATURES

DEVELOPS



UPTO
5,000 PSI
(345 BAR)

DELIVERS

UPTO
0.50 GM / STROKE
(0.70 OZ. / 40 STROKES)

FILLING OPTIONS

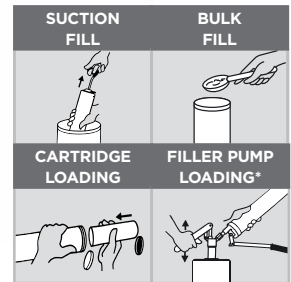

*Only G5-PRO

ORDERING INFORMATION

CAT NR.	ORD NR.	CAT NR.	ORD NR.	CARTRIDGE CAPACITY		BULK CAPACITY	THREADS	BOX QTY.
				(OZ.)	(GMS)			
4" (100 MM) STEEL EXTENSION & COUPLER		12" (300 MM) FLEXIBLE HOSE & COUPLER						
G5R/B	43000	G5F/B	43020	14	400	500	1/8" BSPT	16
G5R/M	43001	G5F/M	43021	14	400	500	M10 x 1	16
* G5R/N	43002	* G5F/N	43022	14	400	500	1/8" NPT	16
* G4R/PST/B	43080	* G4F/PST/B	43085	-	450	650	1/8" BSPT	16
G5R/PRO/B	43050	G5F/PRO/B	43070	14	400	500	1/8" BSPT	16
G5R/PRO/M	43051	G5F/PRO/M	43071	14	400	500	M10 x 1	16
G5R/PRO/N	43052	* G5F/PRO/N	43072	14	400	500	1/8" NPT	16

* Best Seller

Unique concept & design for quick and clear lubricant identification eliminating the risk of cross contamination or mixing of incompatible lubricants

Tough, impact and drop resistant polycarbonate tube with aluminium die cast adaptors

High tolerance aluminium die cast head with steel block nut

Super strong pistol grip handle designed to prevent pinching of fingers

Complete with

4" (100 mm) steel extension & coupler, 12" (300 mm) x 0.33" (8.5 mm) flexible hose & coupler

Barrel available as spare also



Quick lubricant identification eliminating the risk of mixing incompatible or unspecified lubricants

Clear Tube Barrel only

FEATURES

DEVELOPS	
	UPTO 5,000 PSI (345 BAR)
DELIVERS	
UPTO 0.50 GM / STROKE (0.70 OZ. / 40 STROKES)	

FILLING OPTIONS

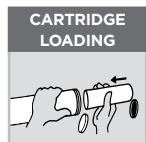

ORDERING INFORMATION

CAT NR.	ORD NR.	CARTRIDGE CAPACITY		BULK CAPACITY (CM ³)	THREADS	BOX QTY.
		(OZ.)	(GMS)			
GREASE GUN						
G5RF/B-CL	46920	14	400	500	1/8" BSPT	16
G5RF/M-CL	46921	14	400	500	M10 x 1	16
G5RF/N-CL	46922	14	400	500	1/8" NPT	16
G4RF/PST/B-CL	46923	-	450	650	1/8" BSPT	16
BARREL ONLY						
BRL/G1-CL	46990	Replacement clear tube barrel only 14 oz. (400 gms)			2.2806" x 16 UNF	20
BRL/G4-CL	46991	Replacement clear tube barrel only 450 gms			2.5" x 16 UNF	20

WARNING

Designed for use with grease only: Do not use with: ESTER based Greases, Synthetic Greases such as Aeroshell 33 Grease, Aeroshell 7 Grease, Skydrol Products etc. These have an adverse effect on the clear polycarbonate tube & can cause fogging, cracking & fracturing of the tube.



One hand operated Grease Gun with dual discharge ports - front and top

Dual discharge ports
Makes greasing on inaccessible fittings very convenient

Heavy duty aluminium die cast head with one hand operated pistol handle

Handle designed to prevent fingers from "pinching"

High visibility plated finish

Complete with
4" (100 mm) steel extension and 12" (300 mm x 0.33"(8.5 mm)) flexible hose & coupler



Top Port



Front Port



FEATURES

DEVELOPS	
	UPTO 5,000 PSI (345 BAR)
DELIVERS	
UPTO 0.50 GM / STROKE (0.70 OZ. / 40 STROKES)	

FILLING OPTIONS

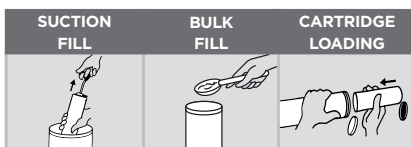

ORDERING INFORMATION

CAT NR.	ORD NR.	CARTRIDGE CAPACITY		BULK CAPACITY	THREADS	BOX QTY.
		(OZ.)	(GMS)			
G31RF/B	43015	14	400	500	1/8" BSPT	16
G31RF/M	43016	14	400	500	M10 x 1	16
* G31RF/N	43017	14	400	500	1/8" NPT	16

* Best Seller

Ergonomic One Hand Operated Grease Gun

Unique Adjustable Stroke Mechanism
Easy shift between high volume and high pressure greasing, especially useful in cold conditions

Built Tough

- Barrel with 0.049" (1.2 mm) wall thickness
- CNC machined aluminium die cast head with drop resistant pistol assembly
- Solid 0.43" (11 mm) dia. piston for higher grease discharge per stroke

Suitable for use with NLGI 1, 2, 3 greases

Complete with

12" (300 mm) x 0.425" (11 mm) heavy duty hose & coupler



UNIQUE ADJUSTABLE MECHANISM
HIGH PRESSURE / HIGH VOLUME
High Pressure for use in cold weather
High volume for faster greasing

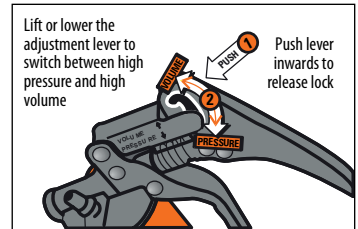

VARIANTS

G55

2-1/4" (57.15 MM)

Use with 14 oz. (400 gms) grease cartridge/500cc bulk fill

G65

63.5 MM

Use with 450 gms grease cartridge popular in Australia & New Zealand

FEATURES

DEVELOPS		DELIVERS
	UPTO 5,000 PSI (345 BAR)	UPTO 0.84 GM / STROKE (1 OZ. / 36 STROKES)

FILLING OPTIONS

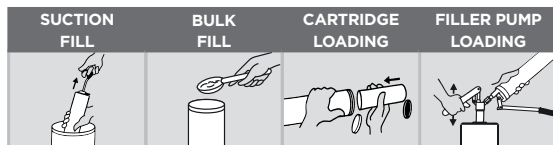

ORDERING INFORMATION

CAT NR.	ORD NR.	CARTRIDGE CAPACITY		BULK CAPACITY (CM ³)	THREADS	BOX QTY.
		(OZ.)	(GMS)			
G55F-HP/B	43095	14	400	500	1/8" BSPT	16
G55F-HP/M	43096	14	400	500	M10 x 1	16
G55F-HP/N	43098	14	400	500	1/8" NPT	16
* G65F-HP/B	43088	-	450	650	1/8" BSPT	16

* Best Seller



Ideal combination of superior quality & value price

Aluminium die cast head fitted with automatic air bleeder valve

Black powder coated finish

Available in 2 choices



- a. 4" (100 mm) steel extension & coupler
- b. 12" (300 mm) x 0.33" (8.5 mm) flexible hose & coupler



FEATURES

DEVELOPS	
	UPTO 5,000 PSI (345 BAR)
DELIVERS	
UPTO 0.50 GM / STROKE (0.70 OZ. / 40 STROKES)	

FILLING OPTIONS

SUCTION FILL	BULK FILL
	
CARTRIDGE LOADING	
	

ORDERING INFORMATION

CAT NR.	ORD NR.	CAT NR.	ORD NR.	CARTRIDGE CAPACITY		BULK CAPACITY	THREADS	BOX QTY.
				(OZ.)	(GMS)			
4" (100 MM) STEEL EXTENSION & COUPLER		12" (300 MM) FLEXIBLE HOSE & COUPLER						
V5R/BL/B	42954	V5F/BL/B	42973	14	400	500	1/8" BSPT	16
V5R/BL/M	42955	V5F/BL/M	42974	14	400	500	M10 x 1	16
V5R/BL/N	42956	V5F/BL/N	42975	14	400	500	1/8" NPT	16

'Ultimate' All Weather Pistol Grip Grease Guns

All weather grease gun designed for convenient use even in very cold weather conditions

Built Tough

- Barrel with 0.049" (1.2 mm) wall thickness
- Heavy duty follower spring
- CNC machined aluminium die cast head with bulk loader valve that double as an air bleeder
- Rolled threads for quick & easy re-loading
- Heavy duty plunger spring keeps grease compressed and free of air pockets

Venturi Mechanism coupled with a large grease inlet helps retain prime

Also available with **Unique Adjustable Stroke Mechanism** that switches between high pressure and high volume easily

High volume for faster greasing & high pressure for use in very cold weather conditions



Grease Gun Head with large grease inlet with venturi action

VARIANTS

G70



2-1/4"
(57.15 MM)

Use with 14 oz. (400 gms) grease cartridge / 500cc bulk fill

With double lipped follower for ease of use with cartridge or bulk grease without changeover

Comes with 18" (450mm) x 0.425" (11mm) high pressure grease hose & coupler

G80



2-1/4"
(57.15 MM)

Adjustable Stroke Mechanism

Use with 14 oz. (400 gms) grease cartridge / 500cc bulk fill

Comes with 12" (300mm) x 0.425" (11mm) high pressure grease hose & coupler

G85



63.5 MM

Adjustable Stroke Mechanism

Use with 450 gms. grease cartridge

Comes with 12" (300mm) x 0.425" (11 mm) high pressure grease hose & coupler

FILLING OPTIONS

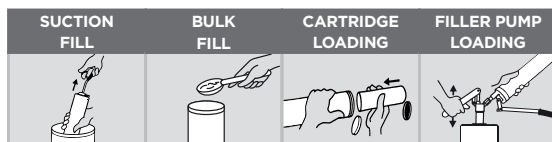

G70**G80****G85**

Rugged die-cast handle

Aluminium die cast head with unique bulk loader which doubles as an air bleeder

Compression Spring



**UNIQUE ADJUSTABLE MECHANISM
HIGH PRESSURE / HIGH VOLUME**

High Pressure for use in cold weather
High volume for faster greasing

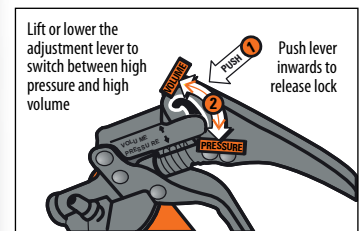

Lift or lower the adjustment lever to switch between high pressure and high volume

1 Push lever inwards to release lock
2

FOR G70

DEVELOPS		DELIVERS	
	UPTO 7,000 PSI (483 BAR)	UPTO 0.68 GM / STROKE (1 OZ. / 40 STROKES)	

ORDERING INFORMATION

CAT NR.	ORD NR.	CARTRIDGE CAPACITY		BULK CAPACITY (CM ³)	THREADS	BOX QTY.
		(OZ.)	(GMS)			
WITHOUT UNIQUE ADJUSTABLE STROKE MECHANISM						
G70F-HP18/B	43040	14	400	500	1/8" BSPT	16
G70F-HP18/M	43041	14	400	500	M10 x 1	16
* G70F-HP18/N	43042	14	400	500	1/8" NPT	16

* Best Seller

FOR G80 & G85

DEVELOPS		DELIVERS	
	UPTO 6,000 PSI (413 BAR)	UPTO 0.90 GM / STROKE (1.30 OZ. / 40 STROKES)	

ORDERING INFORMATION

CAT NR.	ORD NR.	CARTRIDGE CAPACITY		BULK CAPACITY (CM ³)	THREADS	BOX QTY.
		(OZ.)	(GMS)			
WITH UNIQUE ADJUSTABLE STROKE MECHANISM						
G80F-HP/B	43045	14	400	500	1/8" BSPT	10
G80F-HP/M	43046	14	400	500	M10 x 1	10
* G80F-HP/N	43047	14	400	500	1/8" NPT	10
* G85F-HP/B	43048	-	450	650	1/8" BSPT	10

* Best Seller



Quick-Load Technology is a unique concept that allows for fast reloading process. Quick-Load features threadless quick connect barrel that significantly reduces downtime. Simply pull the Quick-Load switch to dis-engage the barrel. Never worry about crossing threads on your barrel again!

Un-matched quality & performance from a ONE HAND GREASE GUN

Built Tough

Aluminium die cast head fitted with bulk loader and automatic air bleeder valve that bleeds out air while loading the gun eliminating the need to manually operate the valve

Also available with **Unique Adjustable Stroke Mechanism** that switches between high volume and high pressure applications easily

Venturi Mechanism coupled with a large grease inlet helps retain prime

Double lipped follower allows use with cartridge or bulk grease without change-over

For use with NLGI 1, 2 & 3

Complete with 18" (450 mm) × 0.425" (11 mm) high pressure flexible hose & coupler

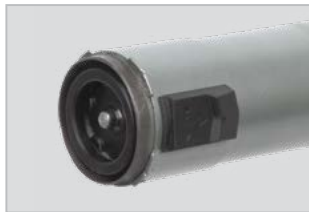

Thread-less QUICK-LOAD barrel

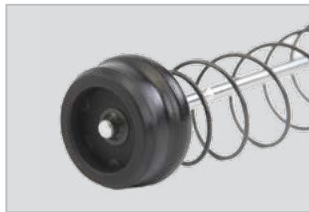

Premium Double Lipped Grease Follower



Grease gun head with large grease inlet with Venturi Action

FOR G70Q

DEVELOPS		DELIVERS	
	UPTO 7,000 PSI (483 BAR)	UPTO 0.68 GM / STROKE (1 OZ. / 40 STROKES)	

ORDERING INFORMATION

CAT NR.	ORD NR.	CARTRIDGE CAPACITY		BULK CAPACITY	THREADS	BOX QTY.
		(OZ.)	(GMS)			
WITHOUT ADJUSTABLE STROKE MECHANISM						
G70Q/F-HP18/B	43034	14	400	500	1/8" BSPT	10
G70Q/F-HP18/M	43035	14	400	500	M10 × 1	10
G70Q/F-HP18/N	43036	14	400	500	1/8" NPT	10

G80Q

G70Q



**UNIQUE ADJUSTABLE MECHANISM
HIGH PRESSURE / HIGH VOLUME**

High Pressure for use in cold weather
High volume for faster greasing

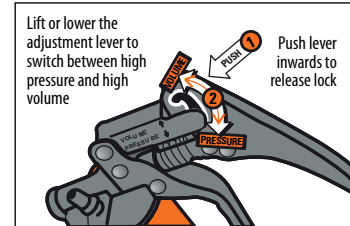

FOR G80Q

DEVELOPS		DELIVERS	
	6,000 PSI (413 BAR)	UPTO 0.90 GM / STROKE (1 OZ. / 31 STROKES)	

ORDERING INFORMATION

CAT NR.	ORD NR.	CARTRIDGE CAPACITY		BULK CAPACITY	THREADS	BOX QTY.
		(OZ.)	(GMS)			
WITH ADJUSTABLE STROKE MECHANISM						
G80Q/F-HP18/B	43043	14	400	500	1/8" BSPT	10
G80Q/F-HP18/M	43044	14	400	500	M10 x 1	10
G80Q/F-HP18/N	43049	14	400	500	1/8" NPT	10

FILLING OPTIONS

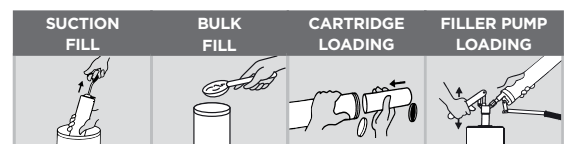

"SUPA-LITE" lightweight aluminium grease guns

Designed for fatigue free & comfortable everyday greasing in automotive, fleet, industrial, farm & construction applications

Barrel made from lightweight yet strong aircraft grade 0.063" (1.6 mm) thick aluminium

Aluminium die cast head fitted with steel block nut

Super strong pistol grip handle designed to prevent 'pinching'

Dual Discharge Ports

Front & top port make greasing on inaccessible fitting very convenient

Available in 2 choices

- a. 4" (100 mm) steel extension & coupler
- b. 18" (450 mm) x 0.33" (8.5 mm) flexible hose & coupler



FEATURES

DELIVERS	
UPTO 0.5 GM / STROKE (1 OZ. / 56 STROKES)	
DEVELOPS	
	UPTO 5,000 PSI (345 BAR)

FILLING OPTIONS

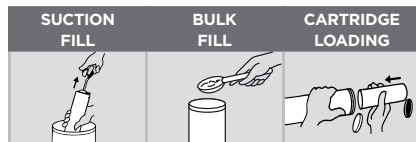

ORDERING INFORMATION

CAT NR.	ORD NR.	CAT NR.	ORD NR.	CARTRIDGE CAPACITY		BULK CAPACITY	THREADS	BOX QTY.
				(OZ.)	(GMS)			
4" (100 MM) STEEL EXTENSION & COUPLER		18" (450 MM) FLEXIBLE HOSE & COUPLER						
G31R/AL/BL/B	43064	G31F-18/AL/BL/B	43067	14	400	500	1/8" BSPT	16
G31R/AL/BL/M	43065	G31F-18/AL/BL/M	43068	14	400	500	M10 x 1	16
G31R/AL/BL/N	43066	G31F-18/AL/BL/N	43069	14	400	500	1/8" NPT	16

Specially designed push type grease gun to lubricate hammer mechanism in impact wrenches with flush type grease fittings

Small tip opening ensures precise placement of lubricant in any application

Die cast aluminium head with 2 threaded pockets to hold spare needle nozzles

Compatible with most flush type fittings

Includes needle nozzles with size:

1. 0.028" (0.7 mm)
2. 0.039" (1.0 mm)
3. 0.055" (1.4 mm)

FEATURES

DEVELOPS		DELIVERS	
	UPTO 1,000 PSI (69 BAR)	UPTO 1 OZ (28 GMS) / 95 STROKES	

FILLING OPTIONS

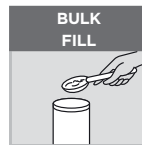

ORDERING INFORMATION

CAT NR.	ORD NR.	CAPACITY		BOX QTY.
		OZ.	GMS	
G3P	43105	3	85	36

Threaded Pockets
 0.028" (0.7 mm) 0.039" (1.0 mm) 0.055" (1.4 mm)



Ø
1.42" (36 MM)

Specially designed push type grease gun to lubricate hammer mechanism in air tools with flush type grease fittings, lawn mowers, ATV, RV's, etc.

Tough, impact & drop-resistant polycarbonate clear tube for quick lubricant identification eliminating the risk of cross-contamination or mixing of incompatible lubricants

Die-cast Aluminium head with 2 threaded pockets holding spare needle nozzles

Small tip opening ensures precise placement of lubricants

Includes needle nozzles in sizes:

1. 0.028" (0.7 mm)
2. 0.039" (1.0 mm)
3. 0.055" (1.4 mm)

FEATURES

DEVELOPS		DELIVERS	
	UPTO 1,000 PSI (69 BAR)	UPTO 1 OZ (28 GMS) / 95 STROKES	

FILLING OPTIONS

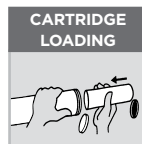

Lubricating impact wrench



ORDERING INFORMATION

CAT NR.	ORD NR.	CARTRIDGE CAPACITY	
		(OZ.)	(GMS)
G3P/CL	43106	3	85

NEW!

Threaded Pockets
 0.028" (0.7 mm) 0.039" (1.0 mm) 0.055" (1.4 mm)



One hand pistol grip grease gun with convenient pull type operating mechanism

Available in a choice of textured black powder coated or textured zinc plated finish

Complete with 4" (100 mm) steel extension and 4 jaw coupler with ball check

FEATURES

DEVELOPS	
	UPTO 3,500 PSI (240 BAR)
DELIVERS	
	UPTO 0.40 GM / STROKE (0.60 OZ. / 40 STROKES)

FILLING OPTION

CARTRIDGE LOADING



ORDERING INFORMATION

CAT NR.	ORD NR.	CAT NR.	ORD NR.	CARTRIDGE CAPACITY		THREADS	BOX QTY.
				(OZ.)	(GMS)		
BLACK POWDER COATED FINISH		ZINC PLATED FINISH					
* G-16/B	43250	G-16/ZN/B	43260	3	85	1/8" BSPT	30
G-16/M	43251	G-16/ZN/M	43261	3	85	M10 x 1	30
G-16/N	43252	* G-16/ZN/N	43262	3	85	1/8" NPT	30

* Best Seller

27

Mini Pistol Grease Gun Clear Tube

G16-CL

Unique Grease Gun design with a complete see through Clear Tube Grease Barrel

Clear tube provides quick & clear lubricant identification eliminating the risk of cross contamination due to mixing of incompatible lubricants and also provides a visual check grease in the barrel, air pockets etc

Tough, impact & drop resistant polycarbonate tube with aluminium adaptors

Designed for use with grease cartridge 3 oz./85 gms) or Bulk Grease (120 cc)

Complete with 4" (100 mm) steel extension & coupler

NEW!

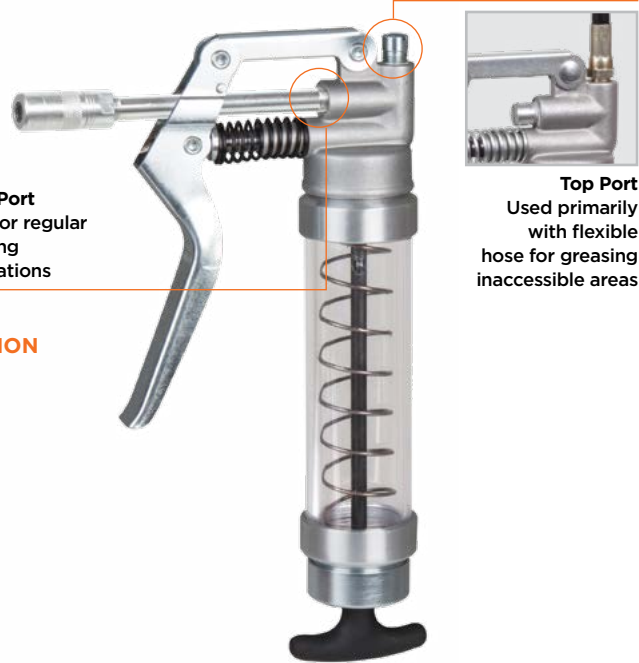

Front Port
Used for regular greasing applications

Top Port
Used primarily with flexible hose for greasing inaccessible areas

FEATURES

DEVELOPS	DELIVERS
 <p>UPTO 3,500 PSI (240 BAR)</p>	<p>UPTO 0.40 GM/STROKE (0.60 OZ./40 STROKES)</p>

FILLING OPTION

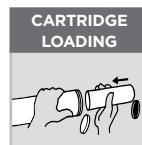

ORDERING INFORMATION

CAT NR.	ORD NR.	THREADS
G-16/CL/B	43265	1/8" BSPT
G-16/CL/M	43266	M10 x 1
G-16/CL/N	43267	1/8" NPT

28

Mini Pistol Grease Gun Popular

G15

Low cost, compact tool box size grease gun, perfect for hard to reach jobs

One hand Pistol grip grease gun with push type operating mechanism

Aluminum die cast head

Textured powdered coated finish for non-slip grip



∅
1.42"
(36 MM)

FEATURES

DEVELOPS	DELIVERS
 <p>UPTO 3,000 PSI (207 BAR)</p>	<p>UPTO 0.40 GM / STROKE (0.60 OZ. / 40 STROKES)</p>

FILLING OPTION

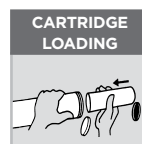

ORDERING INFORMATION

CAT NR.	ORD NR.	CARTRIDGE CAPACITY		THREADS	BOX QTY.
		(OZ.)	(GMS)		
G-15/B	43200	3	85	1/8" BSPT	30
G-15/M	43201	3	85	M10 x 1	30
* G-15/N	43202	3	85	1/8" NPT	30

* Best Seller

29

Mini Lever Grease Gun

G14

When you need a tough little grease gun for hard to get in places, that doesn't take up a lot of space, THIS IS IT!

Compact tool box size gun

Aluminium die cast head

Complete with 6" (150 mm) steel extension & coupler

FEATURES

DEVELOPS	DELIVERS
 <p>UPTO 6,000 PSI (413 BAR)</p>	<p>UPTO 0.55 GM / STROKE (0.80 OZ. / 40 STROKES)</p>

FILLING OPTIONS

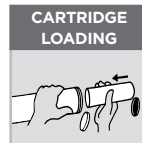

9-1/4"
(235 mm)

1.42"
(36 mm)



ORDERING INFORMATION

CAT NR.	ORD NR.	CARTRIDGE CAPACITY		THREADS	BOX QTY.
		(OZ.)	(GMS)		
G14R/B	43280	3	85	1/8" BSPT	30
G14R/M	43281	3	85	M10 x 1	30
G14R/N	43282	3	85	1/8" NPT	30

30

Push Type Grease Guns

G6P

G7P

Compact toolbox size, ideal for greasing impact wrenches, lawn mowers, chain saws, trailers, ATV's, trucks etc

Push type mechanism for use with bulk grease only

Complete with Universal connector

Custom built options with pointed nozzles available on request

FEATURES

DEVELOPS	DELIVERS
 <p>UPTO 1,000 PSI (69 BAR)</p>	<p>UPTO 0.90 GM / SHOT (1 OZ. / 32 SHOTS)</p>

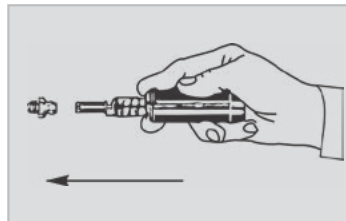

Align Push Gun straight with fitting

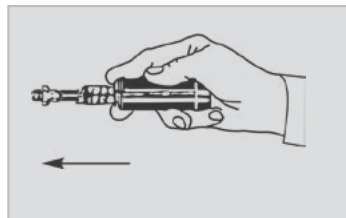

Push with palm of hand

FILLING OPTIONS

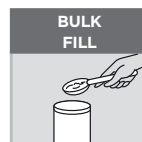

G7P
Capacity
125 cc

ORDERING INFORMATION

CAT NR.	ORD NR.	BULK CAPACITY	BOX QTY.
		(CM ³)	
G6P	43100	30	50
* G7P	43101	125	50

* Best Seller



Filler gun for quick filling high viscosity grease in cylinders of central lubrication system

Simple method of filling grease reservoirs, reduces the chances of contamination

Can be used with 14 oz. (400 gm) grease cartridge / bulk grease

Manufactured from high quality zinc plated steel

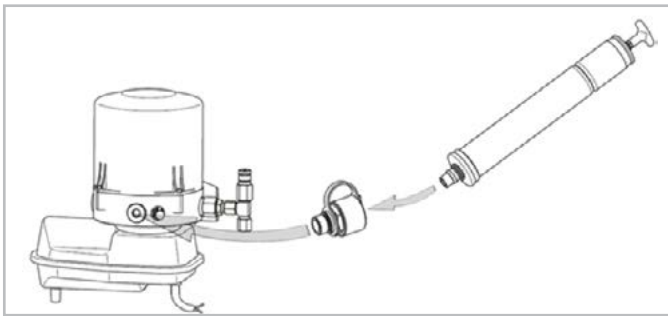

NEW!

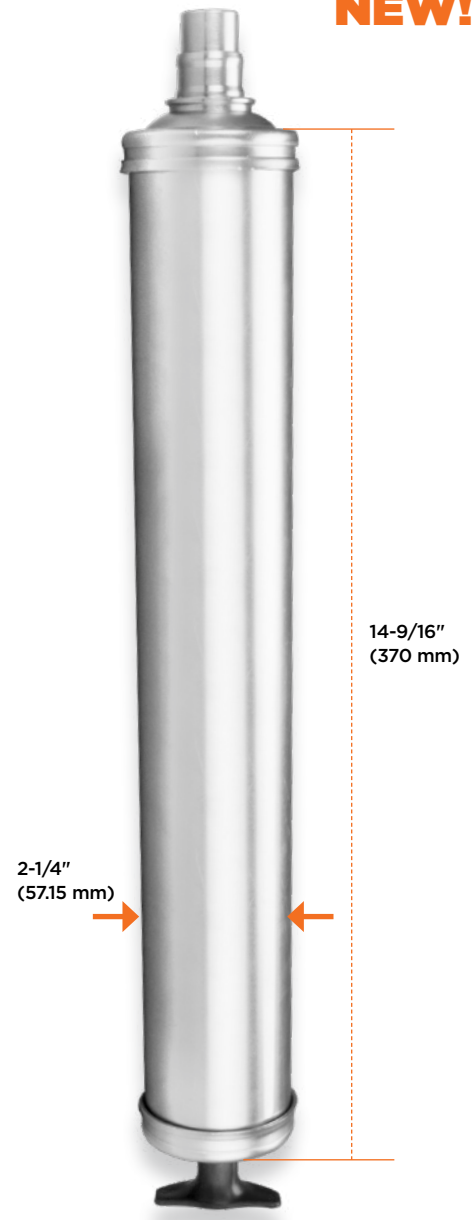

ORDERING INFORMATION

CAT NR.	ORD NR.	CARTRIDGE CAPACITY		BULK CAPACITY
		(OZ.)	(GMS)	(CM ³)
SG/GR/400T	45261	14	400	700

High power one shot air grease gun

Designed with grease cylinder on top for optimal balance

For use in factory maintenance, farm, fleet service or for use from vehicle air brake compressors

Available in 2 choices

- a. 6" (150 mm) steel extension & coupler
- b. 9" (225 mm) x 0.425" (11 mm) high pressure flexible hose & professional coupler

Pressure Ratio
50:1



Aluminium die cast head fitted with bulk loader valve

Extra heavy duty one hand operation with large clearance for trigger



Aluminum die cast construction with piston bore precision honed for rapid action

Air Inlet threaded 1/4" (F). Each gun supplied with a male quick coupler fitting

FEATURES

DEVELOPS
 <p>UPTO 6,000 PSI (413 BAR)</p>
DELIVERS
<p>UPTO 0.68 GM / SHOT (1 OZ. / 40 SHOTS)</p>

FILLING OPTIONS

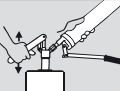
SUCTION FILL	BULK FILL
	
CARTRIDGE LOADING	FILLER PUMP LOADING
	

SPECIFICATIONS

AIR OPERATING RANGE	40-120 PSI (3-8 BAR)
PRESSURE RATIO	50:1
AIR COMPRESSOR VOLUME	1 CFM / 0.026 CBM @ 6 BAR
AIR INLET THREADING	1/4" (F)

ORDERING INFORMATION

CAT NR.	ORD NR.	CAT NR.	ORD NR.	THREADS	BOX QTY.
6" (150 MM) STEEL EXTENSION & COUPLER		9" (225 MM) HIGH PRESSURE FLEXIBLE HOSE & COUPLER			
★ G64R/B	43360	G64F-HP9/B	43370	1/8" BSPT	10
★ G64R/M	43361	★ G64F-HP9/M	43371	M10 x 1	10
G64R/N	43362	★ G64F-HP9/N	43372	1/8" NPT	10

★ Best Seller

WARNING

Always use lubricator unit with air supply

Air Operated Grease Guns are ideal for applications requiring frequent greasing such as in automotive workshops, manufacturing facilities etc.

Patented Design

Fully automatic free outflow and single shot / grease discharge on demand in 'ONE GUN'

Designed for outstanding durability and dependability, this 'ONE GUN' eliminates the need to have two separate guns - continuous flow and single shot

Built Tough

- Heavy duty and durable Aluminium die cast head with precision honed internal bore. Head fitted with bulk loader that doubles as an air bleeder
- Ergonomic pistol grip and acute angle design for higher balance and ease of use, especially in narrow work spaces
- Sturdy variable trigger mechanism to dispense grease
- Grease gun barrel in premium powder coated finish with clip mounted on the barrel for securing hose & coupler when not in use

Dual Mode

- Switch between fully automatic- continuous grease flow operation and on demand/single shot operation, with the slide of an easy to use button

Complete With

30" (760 mm) flexible grease hose & coupler

Pressure Ratio **45:1**



Slide backwards for Continuous Mode



Press button for Single Shot operation



Comes with 30" flexible hose with coupler

SPECIFICATIONS:

AIR OPERATING RANGE	40 - 120 PSI (3 - 8 BAR)
PRESSURE RATIO	45:1
AIR COMPRESSOR VOLUME	1 CFM/ 0.026 CBM @ 6 BAR
AIR INLET THREADS	1/4"(F)

FEATURES

DEVELOPS	DELIVERS (ONE SHOT MODE)	DELIVERS (CONTINUOUS FLOW)
UPTO 6,000 PSI (413 BAR)	UPTO 0.90 GM / SHOT (1.30 OZ. / 40 STROKES)	UPTO 400 GM / MIN (14 OZ./MIN)

ORDERING INFORMATION

CAT NR.	ORD NR.	CARTRIDGE CAPACITY		BULK CAPACITY	THREADS
		(OZ)	(GMS)	(CM ³)	
APGG/1F-30/B	43364	14	400	500	1/8" BSPT
APGG/1F-30/M	43365	14	400	500	M10 X 1
APGG/1F-30/N	43366	14	400	500	1/8" NPT

FILLING OPTIONS

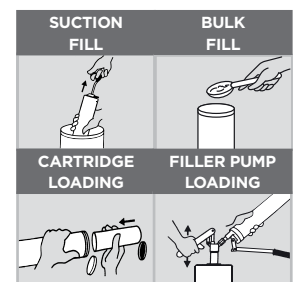

Ideal for use in factory maintenance, agricultural applications, fleet service or for use on trucks connected to vehicle air brake compressors

Available in 2 versions

a. Intermittent (PGG)

Grease discharge with every press of trigger

b. Automatic (AGG)

Continuous grease discharge with the trigger pressed

Available in 2 choices

- a. 6" (150 mm) steel extension & coupler
- b. 12" (300 mm) x 0.33" (8.5 mm) flexible hose & coupler

SPECIFICATIONS

AIR OPERATING RANGE	40-120 PSI (3-8 BAR)
PRESSURE RATIO	40:1
AIR COMPRESSOR VOLUME	1 CFM / 0.026 CBM @ 6 BAR
AIR INLET THREADING	1/4" (F)

FEATURES

DEVELOPS



UPTO
4,800 PSI
(330 BAR)

FOR PGG

DELIVERS

UPTO
0.90 GM / SHOT
(1.30 OZ. / 40 STROKES)

FOR AGG

DELIVERS

UPTO
400 GM / MIN
(14 OZ./MIN)

FILLING OPTIONS

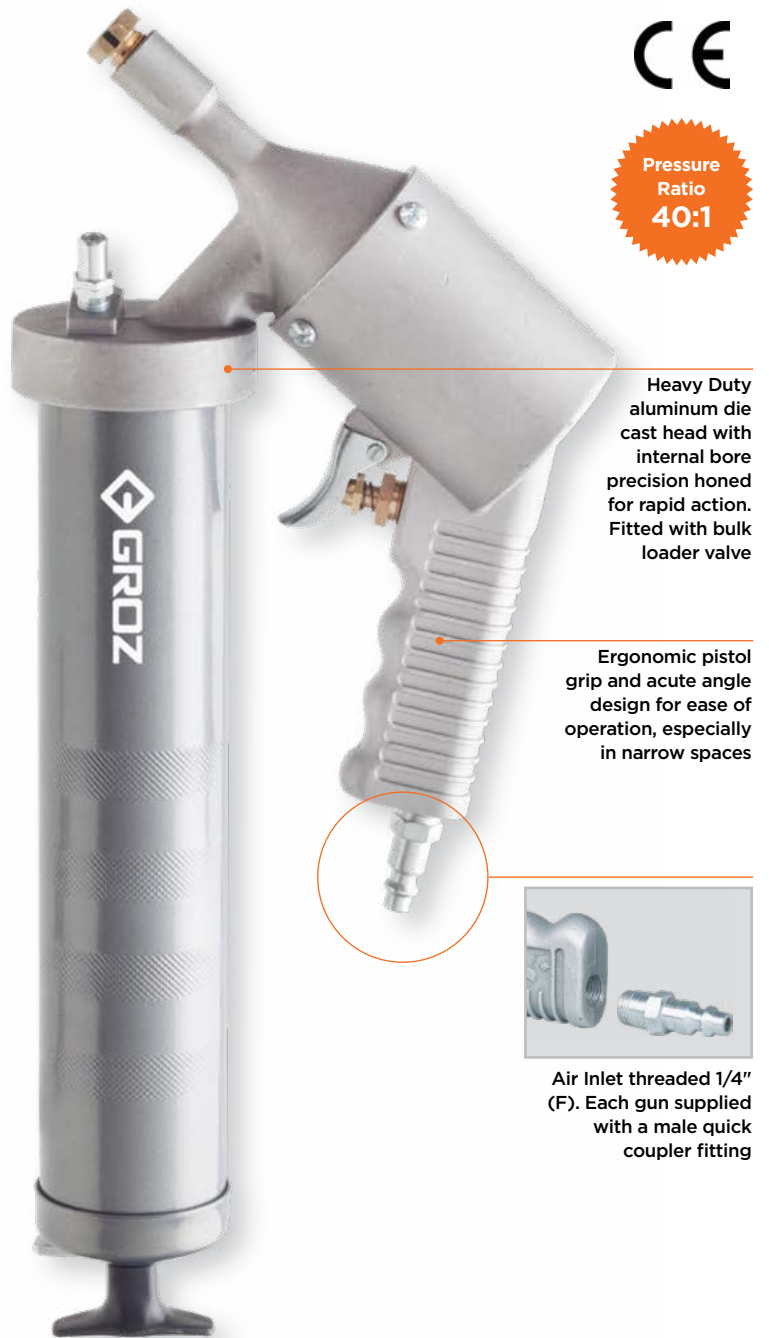
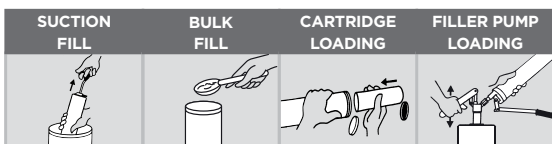

Heavy Duty aluminum die cast head with internal bore precision honed for rapid action. Fitted with bulk loader valve

Ergonomic pistol grip and acute angle design for ease of operation, especially in narrow spaces



Air Inlet threaded 1/4" (F). Each gun supplied with a male quick coupler fitting

WARNING

Always use lubricator unit with air supply

PGG-1**AGG-1****PGG-4****AGG-4****VARIANTS**

PGG-1		\varnothing 2-1/4" (57.15 MM)	Intermittent action with grease discharge per shot Use with 14 oz. (400 gms) grease cartridge or 500 cc bulk
PGG-4		\varnothing 63.5 MM	Intermittent action with grease discharge per shot Use with 450 gms grease cartridge, popular in Australia & New Zealand
AGG-1		\varnothing 2-1/4" (57.15 MM)	Automatic action with continuous grease discharge Use with 14 oz. (400 gms) grease cartridge or 500 cc bulk grease
AGG-4		\varnothing 63.5 MM	Automatic action with continuous grease discharge Use with 450 gms grease cartridge, popular in Australia & New Zealand

ORDERING INFORMATION

CAT NR.	ORD NR.	CAT NR.	ORD NR.	CARTRIDGE CAPACITY		BULK CAPACITY	THREADS	BOX QTY.
				(OZ.)	(GMS)			
6" (150 MM) STEEL EXTENSION & COUPLER		12" (300 MM) FLEXIBLE HOSE & COUPLER						
INTERMITTENT								
PGG/1R/B	43300	PGG/1F/B	43320	14	400	500	1/8" BSPT	12
PGG/1R/M	43301	PGG/1F/M	43321	14	400	500	M10 × 1	12
* PGG/1R/N	43302	PGG/1F/N	43322	14	400	500	1/8" NPT	12
PGG/4R/B	43380	PGG/4F/B	43385	-	450	650	1/8" BSPT	12
AUTOMATIC								
AGG/1R/B	43303	AGG/1F/B	43323	14	400	500	1/8" BSPT	12
AGG/1R/M	43304	AGG/1F/M	43324	14	400	500	M10 × 1	12
* AGG/1R/N	43305	AGG/1F/N	43325	14	400	500	1/8" NPT	12
AGG/4R/B	43381	AGG/4F/B	43389	-	450	650	1/8" BSPT	12

* Best Seller

High quality battery operated grease guns for superior performance

Designed for use by mechanics, technicians, maintenance staff, farmers etc for everyday greasing and maintenance jobs

Robust Aluminium die cast head fitted with automatic air bleeder & bulk loader valve

One hour quick charger (each battery charge provides power to dispense upto 6 grease cartridge in free flow condition)

Capacity

14 oz. (400 gms)

Complete with 30" (750 mm) high pressure hose with spring guard on both ends (prevents hose from kinking) & 4 jaw grease coupler

Comes in strong blow moulded case for convenient storage and portability

Available as 2 variants

a. 19.2V Ni-Cd Battery

- 19.2V
- Standard 1.5 Ah Ni-Cd Battery Pack
- An additional 1.5 Ah Ni-Cd battery pack for uninterrupted greasing

b. 18.5V Li-ion Battery

- 18.5V
- Standard 1.5 Ah Li-ion Battery Pack Available with a one or two spare battery packs

Safety valve releases grease at pressures over 6,000 PSI, preventing damage to gun due to excessive back pressure

Automatic air bleeder valve







Ni Cd

FEATURES

DEVELOPS	
	UPTO 6,000 PSI (413 BAR)
DELIVERS	
	UPTO 85 GMS / MINUTE (3 OZ / MINUTE) IN FREE FLOW

FILLING OPTIONS

SUCTION FILL 	BULK FILL 
CARTRIDGE LOADING 	FILLER PUMP LOADING 

ORDERING INFORMATION

CAT NR.	ORD NR.	DESCRIPTION	BOX QTY.
19.2V NI-CD BATTERY OPERATED GREASE GUN			
* BPGG/19/US	47200	14 oz. Grease Gun, 110V/60 Hz. Battery Charger with US Plug	3
BPGG/19/EU	47201	14 oz. Grease Gun, 220V/50 Hz. Battery Charger with EU Plug	3
BPGG/19/UK	47202	14 oz. Grease Gun, 220V/50 Hz. Battery Charger with UK Plug	3
BPGG/19/AU	47203	450 gm Grease Gun, 220V/50 Hz. Battery Charger with AU Plug	3
SPARE PARTS & ACCESSORIES			
RB/BPGG/19N	47250	Rechargeable Battery, 19.2V, 1.5 Ah, Ni-Cd	3
BC/BPGG/19N/US	47251	1 hour cUL listed Battery Charger, 110V/60Hz, 19.2V, US Plug	3
BC/BPGG/19N/EU	47252	1 hour CE Energy Saving Battery Charger, 220V/50Hz, 19.2V, EU Plug	3
BC/BPGG/19N/UK	47253	1 hour CE Energy Saving Battery Charger, 220V/50Hz, 19.2V, UK Plug	3
BC/BPGG/19N/AU	47257	1 hour CE Energy Saving Battery Charger, 220V/50Hz, 19.2V, AU Plug	3

* Best Seller



Li Ion



Comes with Blow Moulded Case for conveniently storing when not in use



Shoulder Strap included



Battery Charger



Battery packs

ORDERING INFORMATION

CAT NR.	ORD NR.	DESCRIPTION	BOX QTY.
18.5V LI-ION BATTERY OPERATED GREASE GUN			
* BPGG/19L1/US	47220	14 oz. Grease Gun, 1 pc Li-Ion battery, US Plug	3
* BPGG/19L1/EU	47222	14 oz. Grease Gun, 1 pc Li-Ion battery, EU Plug	3
BPGG/19L1/UK	47224	14 oz. Grease Gun, 1 pc Li-Ion battery, UK Plug	3
BPGG/19L1/AU	47226	450 gm Grease Gun, 1 pc Li-Ion battery, AU Plug	3
BPGG/19L2/US	47221	14 oz. Grease Gun, 2 pcs Li-Ion battery, US Plug	3
BPGG/19L2/EU	47223	14 oz. Grease Gun, 2 pcs Li-Ion battery, EU Plug	3
BPGG/19L2/UK	47225	14 oz. Grease Gun, 2 pcs Li-Ion battery, UK Plug	3
BPGG/19L2/AU	47227	450 gm Grease Gun, 2 pcs Li-Ion battery, AU Plug	3

* Best Seller

ORDERING INFORMATION

CAT NR.	ORD NR.	DESCRIPTION	BOX QTY.
SPARE PARTS & ACCESSORIES			
RB/BPGG/19L	47258	Rechargeable Battery, 18.5V, 1.5 Ah, Li-ion	3
BC/BPGG/19L/US	47259	1 hour cUL listed Battery Charger, 110V/60Hz, 18.5V, US Plug	3
BC/BPGG/19L/EU	47260	1 hour CE Energy Saving Battery Charger, 220V/50Hz, 18.5V, EU Plug	3
BC/BPGG/19L/UK	47261	1 hour CE Energy Saving Battery Charger, 220V/50Hz, 18.5V, UK Plug	3
BC/BPGG/19L/AU	47262	1 hour CE Energy Saving Battery Charger, 220V/50Hz, 18.5V, AU Plug	3
HOS/BG/30/N	47256	30" (760 mm) Replacement Hose	3

36

Hydraulic Couplers Standard

HC-11

HC-10

Ideal for use with grease guns for general maintenance

Narrow coupler design for use on fittings with limited access

Milled slot for easy tightening

Fully hardened spring steel jaws

Available with or without ball check



ORDERING INFORMATION

CAT NR.	ORD NR.	THREADS	BOX QTY.
WITH BALL CHECK			
HC/11/4/B	43510	1/8" BSPT	500
HC/11/4/M	43511	M10 × 1	500
★ HC/11/4/N	43512	1/8" NPT	500
WITHOUT BALL CHECK			
HC/10/4/B	43516	1/8" BSPT	500
HC/10/4/M	43517	M10 × 1	500
HC/10/4/N	43518	1/8" NPT	500

★ Best Seller

CAT NR.	ORD NR.	THREADS	BOX QTY.
SET - PACK OF 54			
HC/11/4/B/ST54	43581	1/8" BSPT	12
HC/11/4/M/ST54	43582	M10 × 1	12
HC/11/4/N/ST54	43583	1/8" NPT	12

FEATURES

PRESSURE	
	UPTO 3,000 PSI (207 BAR)
USE WITH HAND OPERATED GREASE GUNS	4 JAW CONSTRUCTION

37

Hydraulic Couplers Professional

HC-14

HC-18

Best selling coupler for professional use

Hardened coupler body withstands high pressure without deformation

Fully hardened spring steel jaws

Hexagonal nut for easy tightening

Available with or without ball check



ORDERING INFORMATION

CAT NR.	ORD NR.	CAT NR.	ORD NR.	THREADS	BOX QTY.
4 JAW COUPLERS		3 JAW COUPLERS			
WITH BALL CHECK					
★ HC/14/4/B	43500	HC/14/3/B	43503	1/8" BSPT	500
HC/14/4/M	43501	HC/14/3/M	43504	M10 × 1	500
★ HC/14/4/N	43502	★ HC/14/3/N	43505	1/8" NPT	500
WITHOUT BALL CHECK					
HC/18/4/B	43535	HC/18/3/B	43507	1/8" BSPT	500
HC/18/4/M	43536	HC/18/3/M	43508	M10 × 1	500
★ HC/18/4/N	43537	HC/18/3/N	43509	1/8" NPT	500

★ Best Seller

CAT NR.	ORD NR.	THREADS	BOX QTY.
SET - PACK OF 54			
HC/14/4/B/ST54	43584	1/8" BSPT	12
HC/14/4/M/ST54	43585	M10 × 1	12
HC/14/4/N/ST54	43586	1/8" NPT	12

FEATURES

PRESSURE	
	UPTO 6,000 PSI (413 BAR)
USE WITH HAND OPERATED GREASE GUNS	

38

Hydraulic Coupler Slim Line

HC-19

For professional use

Amongst the slimmest jaw type grease coupler in the world!

Ideal for use in confined spaces & fittings with narrow access

Hardened coupler body withstands high pressure without deformation

Fully hardened spring steel jaws

Coupler nut & body can be hand tightened for adjusting to variation in grease nipple sizes



Dia.
0.54" (13.7 mm)

ORDERING INFORMATION

CAT NR.	ORD NR.	THREADS	BOX QTY.
HC/19/3/B	43590	1/8" BSPT	500
HC/19/3/M	43591	M10 x 1	500
* HC/19/3/N	43592	1/8" NPT	500

* Best Seller

FEATURES

PRESSURE	USE WITH HAND OPERATED GREASE GUNS	3 JAW CONSTRUCTION
 <p>UPTO 10,000 PSI (690 BAR)</p>		

39

Precision Machined Jaw Coupler

HC-24

Precision machined jaw coupler for high pressure greasing applications

Jaw machined from high tensile steel and assembled into the coupler as a single unit. On usage jaws break away from a single unit into 4 pieces making a perfect fit on the grease nipple

Body & jaws heat treated to withstand high pressures without deformation

Slim construction with 0.59" (15 mm) coupler dia. & milled slot for getting into hard to reach greasing points

Coupler comes without ball check for easy priming

One piece construction



Dia.
0.59" (15 mm)

ORDERING INFORMATION

CAT. NR.	ORD. NR.	THREADS	BOX QTY.
HC/24/4/B	43593	1/8" BSPT	500
* HC/24/4/M	43594	M10 x 1	500
HC/24/4/N	43598	1/8" NPT	500

* Best Seller

FEATURES

PRESSURE	FOR USE WITH HAND OPERATED GREASE GUNS	WITHOUT BALL CHECK
 <p>UPTO 6,000 PSI (413 BAR)</p>		

40 Hydraulic Coupler Heavy Duty HC-12

Recommended for use with air operated grease guns

Hardened coupler body with double wall thickness withstands high pressure without deformation

Fully hardened spring steel jaws

Hexagonal nut for easy tightening

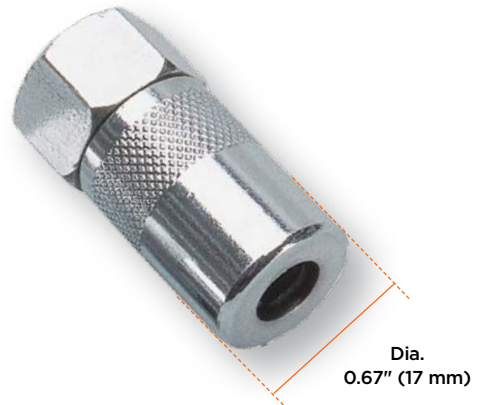







ORDERING INFORMATION

CAT NR.	ORD NR.	THREADS	BOX QTY.
4 JAW COUPLERS			
HC/12/4/B	43520	1/8" BSPT	500
HC/12/4/M	43521	M10 × 1	500
* HC/12/4/N	43522	1/8" NPT	500
3 JAW COUPLERS			
HC/12/3/B	43523	1/8" BSPT	500
HC/12/3/M	43524	M10 × 1	500
HC/12/3/N	43525	1/8" NPT	500

* Best Seller

FEATURES

PRESSURE	3 JAW CONSTRUCTION	4 JAW CONSTRUCTION
 <p>UPTO 10,000 PSI (690 BAR)</p>		
WITH BALL CHECK		FOR USE WITH HAND & AIR OPERATED GREASE GUNS
		

41 Hydraulic Coupler Air-O HC-P

Recommended for use with grease control valves

Hardened coupler body & all internal parts withstand high dynamic pressures without deformation

Fully hardened reversible spring steel jaws for extended service life

Hexagonal nut for easy tightening

100% pressure tested







ORDERING INFORMATION

CAT NR.	ORD NR.	THREADS	BOX QTY.
3 JAW COUPLERS			
HC/P/3/B	43540	1/8" BSPT	400
HC/P/3/M	43541	M10 × 1	400
* HC/P/3/N	43542	1/8" NPT	400

* Best Seller

FEATURES

PRESSURE	3 JAW CONSTRUCTION
 <p>UPTO 7,500 PSI (517 BAR)</p>	
WITH BALL CHECK	
FOR USE WITH HAND & AIR OPERATED GREASE GUNS	
	

42

Hydraulic Coupler 90°

HC-R

Designed for right angled discharge of grease

Very useful for greasing fittings with limited access or in low heights where a grease gun with regular coupler is difficult to use, such as on Chrysler models

Fits all standard grease guns

FEATURES

PRESSURE	WITHOUT BALL CHECK	USE WITH HAND OPERATED GREASE GUNS
<p>UPTO 1,000 PSI (69 BAR)</p>		

ORDERING INFORMATION

CAT NR.	ORD NR.	THREADS	BOX QTY.
HC/R/01/B	43550	1/8" BSPT	500
HC/R/01/M	43551	M10 x 1	500
* HC/R/01/N	43552	1/8" NPT	500

* Best Seller

Hardened slot in coupler reduces wear



Polyurethane seal in coupler fits perfectly on grease fittings



Right angled coupler used for greasing the axle of a low height truck where access to the grease fittings is only through a side

43

Hydraulic Coupler 360°

HC-SW

An excellent coupler for effective lubrication of difficult & hard to reach grease fittings

Jaws are fully hardened for extended service life

Hardened coupler body & swivel joints withstand high-pressure applications without deformation

Zinc plated finish

Spring loaded ball check valve helps retain pressure

Swivels in full 360° circle & locks conveniently at any 45° position. 45° angle gives easy access to most grease fittings

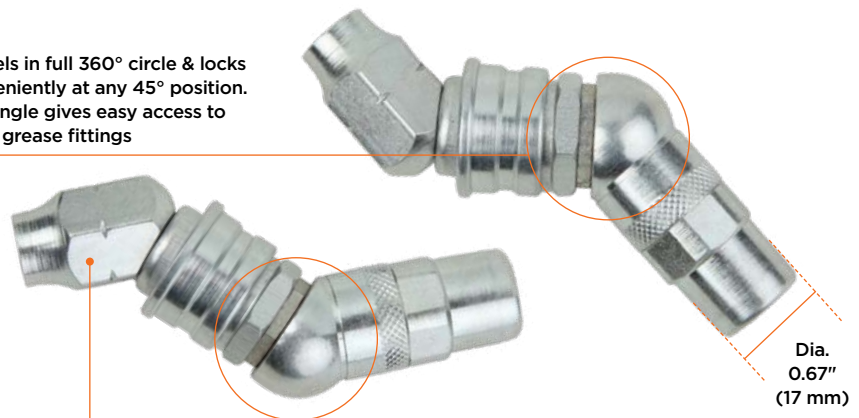

Hexagonal nut allows easy tightening

Dia. 0.67" (17 mm)

ORDERING INFORMATION

CAT NR.	ORD NR.	THREADS	BOX QTY.
HC/SW/3/B	43560	1/8" BSPT	144
HC/SW/3/M	43561	M10 x 1	144
* HC/SW/3/N	43562	1/8" NPT	144

* Best Seller

FEATURES

PRESSURE	3 JAW CONSTRUCTION
<p>UPTO 7,000 PSI (483 BAR)</p>	
<p>WITH BALL CHECK</p>	<p>USE WITH HAND OPERATED GREASE GUNS</p>

44

HC-21

QUICK LOCK GREASE COUPLERS

Quick disconnect coupler for convenient, hands free operation



Disengaging a coupler from a grease fitting, under pressurised conditions is very difficult & often leads to broken fittings or damage to the coupler jaws

The GROZ Quick Lock Grease Couplers take away this worry with their unique 6 point contact design. Designed for quick & convenient dis-engagement of coupler from grease / zerk fittings under pressure

The engagement system moves inside the steel wall when the thumb lever is actuated. This provides additional back support to the mechanism in high pressure applications

Robust Construction
1-1/2" times stronger coupler body is heat treated to withstand high pressures without deformation

Case hardened rollers hold the coupler in position when subjected to high pressure applications

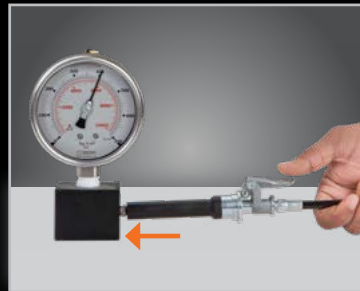

Convenient Engagement
To engage the coupler, simply press the thumb lever & slide the coupler onto the fitting. The hardened 6 cylindrical pins hold the grease/zerk fitting tight.



Easy Release
Once greasing is complete, simply press the thumb lever again to disconnect coupler from the zerk fitting

QUICK COMPARISON

GROZ QUICK LOCK



- The GROZ Quick Lock Coupler gives engagement at 6 points
- Hardened ball points of contact will not get deformed and hence give longer life
- Slim Line Coupler provides easy access into tight areas
- Easy to service/repair

OTHER QUICK COUPLERS

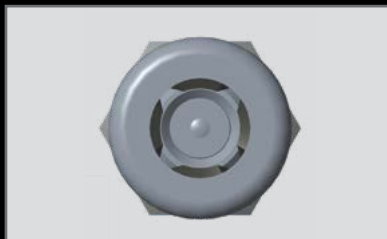

- Provide engagement around the flat surfaces
- Upon repeated use, at varying pressures jaws tend to deform, loosening grip over the fitting
- Very difficult to service/repair



NO MORE MESS



NO MORE BROKEN JAWS



NO MORE BROKEN GREASE FITTINGS

QUICK LOCK - REGULAR



QUICK LOCK - EXTRA LONG **NEW!**

- Especially useful for greasing deep & recessed grease fittings with limited reach
- Suitable for use in harvesters, U-joints, PTO shafts, axles etc.



QUICK LOCK ADVANTAGE

- 1 Convenient Engagement & Dis-engagement**
- 2 Easy Release**
- 3 Hands free operation**
Once engaged the coupler sits firm on the grease / zerk fitting & does not require to be held, as is required with regular couplers. This coupler will not move, thus allowing hands free operation.
- 4 Universal**
The design permits usage on all profiles of Grease Fittings - SAE, DIN, BS etc
- 5 Robust Construction**
Threaded two piece construction for easy repairs

PRESSURE



UPTO
8,000 PSI
(550 BAR)

ORDERING INFORMATION

CAT NR.	ORD NR.	THREADS
QUICK LOCK - REGULAR		
HC/21/B	43544	1/8" BSPT
HC/21/M	43545	M10 x 1
HC/21/N	43546	1/8" NPT
HC/21/BSP	43547	1/8" BSP
QUICK LOCK - EXTRA LONG		
* HC/21L/B	43553	1/8" BSPT
* HC/21L/M	43554	M10 x 1
* HC/21L/N	43543	1/8" NPT

* New

NEW!

Compact & easy access coupler: works with a "Forward Push" both for engaging & dis-engaging from grease fittings.

Getting a coupler off a fitting under pressure is never easy & often results in either damaging the grease fitting or damaging the coupler itself, making greasing an unliked job.

Groz Super Grip Quick Connect Grease Coupler takes the pain out of greasing & offers

1. Quick connection of coupler on grease fittings
2. Convenient dis-engagement of coupler under high pressure
3. Hands free usage: SUPER GRIP jaws hold firmly onto the grease fitting with no chance of grease leakage
4. No grease splash during coupler dis-engagement

Robust construction with heat treated Spring Steel jaws.

4 jaws move inside the hardened body during engagement with the grease fitting. At this time, the hardened coupler body offers back support to the jaws, ensuring no deformation/damage to jaws under high pressure.



Convenient engagement & disengagement with a forward push



FEATURES

PRESSURE

**UPTO
6,000 PSI
(413 BAR)**



- No more broken jaws
- No more broken grease fittings
- No more wastage
- No more mess

ORDERING INFORMATION

CAT NR.	ORD NR.	THREAD
HC/23/4/B	43587	1/8" BSPT(F)
HC/23/4/M	43588	M10 X 1 (F)
HC/23/4/N	43589	1/8" NPT (F)

For additional types of quick couplers, refer to GROZ 'Fluid Handling Catalogue' - pg 52-53

A range of couplers for use with button head grease fittings, found mostly on heavy machinery, agricultural or contractor's equipment

Zinc die cast construction

All couplers have a metal seal that imparts increased resistance to wear

PCN-1

Fixed Push-On for 5/8" (16 mm) Button Head Fittings



PRESSURE

UPTO 3,000 PSI (207 BAR)

BHC-10

Swivelling for 5/8" (16 mm) Button Head Fittings



PRESSURE

UPTO 3,000 PSI (207 BAR)

PCN-3

Medium Duty for 5/8" (16 mm) Button Head Fittings



PRESSURE

UPTO 6,000 PSI (413 BAR)

HOC-1

Fixed Hook-On for 5/8" (16 mm) Button Head Fitting



PRESSURE

UPTO 3,000 PSI (207 BAR)

PCN-2

Heavy Duty for 7/8" (22 mm) Giant Button Head Fittings



PRESSURE

UPTO 7,500 PSI (517 BAR)

ORDERING INFORMATION

CAT NR.	ORD NR.	FOR BUTTON HEAD FITTING SIZE		THREADS	BOX QTY.
		(INCH)	(MM)		
* BHC/10/B	43570	5/8	16	1/8" BSPT	200
BHC/10/N	43572	5/8	16	1/8" NPT	200
* HOC/1/B	43574	5/8	16	1/8" BSPT	250
HOC/1/M	43575	5/8	16	M10 x 1	250
HOC/1/N	43569	5/8	16	1/8" NPT	250
PCN/1/B	43577	5/8	16	1/8" BSPT	250
PCN/1/M	43563	5/8	16	M10 x 1	250
PCN/1/N	43564	5/8	16	1/8" NPT	250
* PCN/3/B	43579	5/8	16	1/8" BSPT	250
* PCN/3/M	43565	5/8	16	M10 x 1	250
* PCN/3/N	43576	5/8	16	1/8" NPT	250
PCN/2/B	43578	7/8	22	1/8" BSPT	125
PCN/2/M	43566	7/8	22	M10 x 1	125
* PCN/2/N	43567	7/8	22	1/8" NPT	125

* Best Seller

FEATURES

WITHOUT BALL CHECK	USE WITH HAND OPERATED GREASE GUNS

GROZ also manufactures a range of button head grease fitting, refer to page 70 for details



47

Hydraulic Coupler Pin Type

HC-13

Quick, positive and leak-proof connection with pin type fittings

Hexagonal nut for easy tightening

FEATURES

PRESSURE	WITHOUT BALL CHECK	FOR USE WITH HAND OPERATED GREASE GUNS
<p>UPTO 3,000 PSI (207 BAR)</p>		



ORDERING INFORMATION

CAT NR.	ORD NR.	THREADS	BOX QTY.
* HC/13/B	43530	1/8" BSPT	500
HC/13/M	43532	M10 x 1	500
HC/13/N	43531	1/8" NPT	500

* Best Seller

48

Needle Nose Dispensers

DNN

Used for dispensing a fine line of grease

Needle design allows easy access on hard to reach hydraulic type fittings in inaccessible areas

Can be directly attached to steel extensions or flexible hoses

FEATURES

PRESSURE	USE WITH HAND OPERATED GREASE GUNS
<p>UPTO 6,000 PSI (413 BAR)</p>	



DNN/1-8

DNN/1-8/S

ORDERING INFORMATION

CAT NR.	ORD NR.	CAT NR.	ORD NR.	NEEDLE LENGTH		NEEDLE DIAMETER		TIP DIAMETER		BOX QTY.
				(INCH)	(MM)	(INCH)	(MM)	(INCH)	(MM)	
1/8" BSPT		1/8" NPT								
NEEDLE NOSE DISPENSERS										
DNN/1-8/B	44850	* DNN/1-8/N	44860	19/32	15	0.187	4.76	0.046	1.17	500
DNN/1-8/S/B (with shroud)	44853	-	-	19/32	15	0.187	4.76	0.046	1.17	500
S/DNN/1-8/B	44854	Replacement shroud only								-
NARROW NEEDLE NOSE DISPENSERS										
DNN/1-1-2/B	44851	* DNN/1-1-2/N	44861	1.1/2	38	0.156	3.96	0.051	1.30	500
DNN/6/B	44852	DNN/6/N	44862	6	150	0.156	3.96	0.051	1.30	500

* Best Seller

DNN/1-1-2

DNN/6



49

Grease Injector Needles

GIN

Used for lubrication in very tight spaces such as universal joints and sealed bearings

Equipped with grease fitting for quick connect operation

Complete with protective plastic holder for safe storage

Available in two types (1) standard (2) safety version with aluminum holder for safe & easy handling

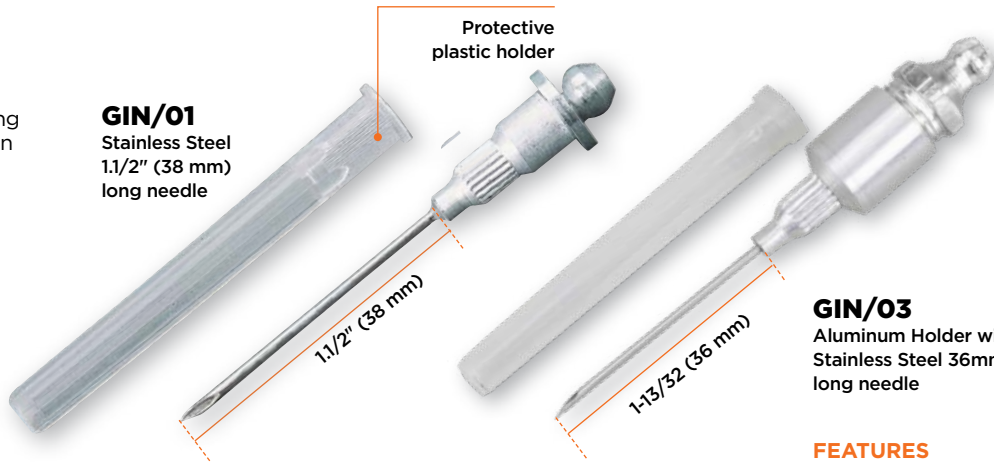

GIN/01
Stainless Steel
1.1/2" (38 mm)
long needle

GIN/03
Aluminum Holder with
Stainless Steel 36mm
long needle

ORDERING INFORMATION

CAT NR.	ORD NR.	TYPE	NEEDLE LENGTH		NEEDLE THICKNESS (GAUGE)	BOX QTY.
			(INCH)	(MM)		
GIN/00	44879	Standard	1-1/2	38	16	1200
* GIN/01	44880	Standard	1-1/2	38	18	1200
GIN/02	44881	Standard	1-1/2	38	21	1200
GIN/03	44882	Safety	1-13/32	36	18	1200

* Best Seller

FEATURES

PRESSURE

UPTO 1,000 PSI (69 BAR)

USE WITH HAND OPERATED GREASE GUNS

50

Seal Off Dispenser

Used for lubricating cars with grease plugs

Oil & grease resistant rubber tip



Replacement tip available as spare

FEATURES

FOR USE WITH HAND OPERATED GREASE GUNS

ORDERING INFORMATION

CAT NR.	ORD NR.	THREADS	BOX QTY.
SOD/01/B	44870	1/8" BSPT	500
SOD/01/N	44871	1/8" NPT	500
TIP/SOD/01	44872	(Replacement Tip Only)	500

51

Grease Gun Cartridge

14 oz. (400 gms) of premium lithium complex red grease

NLGI Grade 2

Non messy, totally clean offering highest convenience in usage

Useful for all automotive, industrial, construction & agricultural applications

Recommended for use with GROZ grease guns



ORDERING INFORMATION

CAT NR.	ORD NR.	DESCRIPTION	BOX QTY.
CTG/01P	45110	Grease Cartridge Capacity 14 oz (400 gms)	10

52

Grease Gun Holder

GGH-01

Simple snap action clamps for safe storage of grease guns and suction guns

Manufactured from heavy gauge steel sheet with zinc plated finish

Mount on almost any surface



ORDERING INFORMATION

CAT NR.	ORD NR.	SUITABLE FOR BARREL DIAMETER	BOX QTY.
* GGH/01	44840	2.1/4" (57.15 mm) on guns suitable for 14 oz. (400 gm) cartridge	180

53

Heavy Duty Grease Gun Holder

GGH-03

Heavy Duty Grease Gun holder, designed especially for use on farm & construction equipment, trailers, tractors & other automobiles in high vibration environment

Sturdy all steel construction with a 4 bolt design for convenient & secure mounting

Heavy Duty Spring

Suitable for use with

- a. 14 oz. (400 gm) capacity grease guns with a 2-1/4" (57.15 mm) dia.
- b. 450 gm capacity grease gun with a 63.5 mm dia. popular in Australia & New Zealand



ORDERING INFORMATION

CAT NR.	ORD NR.	SUITABLE FOR BARREL DIAMETER	BOX QTY.
GGH/03	44842	2.1/4" (57.15 mm) & 63.5 mm barrels popular in Australia & New Zealand	24

54

Flexible / Rigid Grease Gun Extension

Grease Gun Extension with dual configuration

1. Rigid Steel extension 13" (330 mm) long
2. Flexible hose extension

Switch from one to the other by simply sliding the steel tube

Supplied complete with Grease Gun Coupler

Ideal for use with Grease Control valves

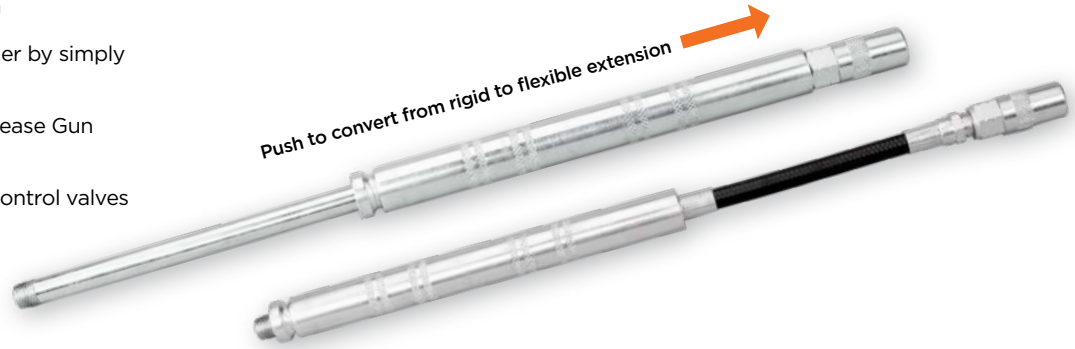

ORDERING INFORMATION

CAT NR.	ORD NR.	THREADS	BOX QTY.
FRC/13/B	44810	1/8" BSPT	100
FRC/13/M	44811	M10 x 1	100
* FRC/13/N	44812	1/8" NPT	100

* Best Seller

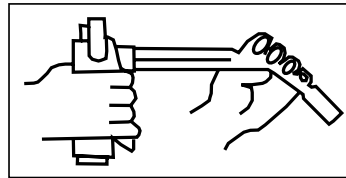

Switches with one hand

FEATURES

WORKING PRESSURE

UPTO
5,000 PSI
(345 BAR)

FOR USE WITH HAND & AIR OPERATED GREASE GUNS

55

Grease Gun Steel Extensions

Steel construction with bright zinc plated finish

High strength rolled threads on both ends

Available in straight & bent construction

ORDERING INFORMATION

CAT NR.	ORD. NR.	LENGTH (END TO END)		THREADS	BOX QTY.
		(INCH)	(MM)		
BENT					
GBP/6/B	44800	6	150	1/8" BSPT	500
GBP/6/M	44801	6	150	M10 x 1	500
GBP/6/N	44802	6	150	1/8" NPT	500
GBP/8/M	44804	8	200	M10 x 1	250
GBP/18/N	44809	18	450	1/8" NPT	100
STRAIGHT					
GSP/4/B	44820	4	100	1/8" BSPT	500
GSP/4/M	44821	4	100	M10 x 1	500
GSP/4/N	44822	4	100	1/8" NPT	500
GSP/5/N	44823	5	125	1/8" NPT	500
GSP/6/B	44827	6	150	1/8" BSPT	500
GSP/6/N	44829	6	150	1/8" NPT	500
GSP/8/M	44817	8	200	M10 x 1	250



Bent



Straight

FEATURES

PRESSURE

UPTO
6,000 PSI
(413 BAR)

USE WITH
HAND OPERATED GREASE GUNS

Note
Other lengths can be custom built on request

Grease flexible hoses allow greasing access to nipples with limited reach. Due to their flexible construction, these are used for greasing hard to reach grease fittings

- Thermoplastic construction
- Inner diameter (d1): 0.14" (3.6 mm)
 - Outer diameter (d2): 0.33" (8.5 mm)

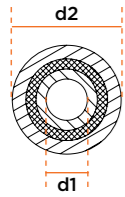

Highly flexible with minimum bending radius of 1.57" (40 mm)

Zinc plated steel end connections with hydraulic crimping

Also available

- Hose fitted with spring guard
- Hose fitted with professional 4 jaw coupler with ball check
- Hose fitted with Swivel

FEATURES

WORKING PRESSURE	
	UPTO 3,500 PSI (240 BAR)
BURST PRESSURE	
	MIN. 11,600 PSI (800 BAR)
USE WITH HAND OPERATED GREASE GUNS	



USEFUL TIPS!

Always buy a good quality hose. Accidents caused by poor quality hose can cause fatal injury

Hose fitted with Professional 4 Jaw Coupler with Ball Check

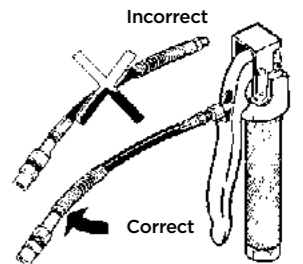

Hose fitted with heavy duty spring guard that imparts rigidity to the coupling end of the hose, allowing added safety & convenience in fit-ment

Hose fitted with swivel

Other lengths can be custom manufactured

WARNING
Never use beyond recommended working pressure

ORDERING INFORMATION

CAT NR.	ORD NR.	CAT NR.	ORD NR.	CAT NR.	ORD NR.	LENGTH (END TO END)		BOX QTY.
						(INCH)	(MM)	
1/8" BSPT		M10 x 1		1/8" NPT				
STANDARD GREASE HOSE								
GHC-6/B	43600	GHC-6/M	43610	GHC-6/N	43620	6	150	1000
GHC-8/B	43601	GHC-8/M	43611	GHC-8/N	43621	8	200	500
GHC-9/B	43602	GHC-9/M	43612	GHC-9/N	43622	9	225	500
GHC-10/B	43603	GHC-10/M	43613	GHC-10/N	43623	10	250	300
★ GHC-12/B	43604	GHC-12/M	43614	GHC-12/N	43624	12	300	300
★ GHC-18/B	43605	GHC-18/M	43615	GHC-18/N	43625	18	450	200
GHC-20/B	43606	GHC-20/M	43616	GHC-20/N	43626	20	500	200

★ Best Seller

ORDERING INFORMATION

CAT NR.	ORD NR.	LENGTH (END TO END)		THREADS	BOX QTY.
		(INCH)	(MM)		
HOSE WITH PROFESSIONAL 4 JAW COUPLER					
★ GHC-12/HC/14/4/B	43630	12	300	1/8" BSPT	250
GHC-18/HC/14/4/B	43631	18	450	1/8" BSPT	250
★ GHC-12/HC/14/4/M	43640	12	300	M10 x 1	250
GHC-18/HC/14/4/M	43641	18	450	M10 x 1	250
★ GHC-12/HC/14/4/N	43650	12	300	1/8" NPT	250
★ GHC-18/HC/14/4/N	43651	18	450	1/8" NPT	250

ORDERING INFORMATION

CAT NR.	ORD NR.	LENGTH (END TO END)		THREADS	BOX QTY.
		(INCH)	(MM)		
HOSE WITH SPRING GUARD					
GHC-12/SPR/B	43660	12	300	1/8" BSPT	300
GHC-18/SPR/B	43661	18	450	1/8" BSPT	200
GHC-12/SPR/M	43670	12	300	M10 x 1	300
GHC-18/SPR/M	43671	18	450	M10 x 1	200
★ GHC-12/SPR/N	43680	12	300	1/8" NPT	300
★ GHC-18/SPR/N	43681	18	450	1/8" NPT	200

ORDERING INFORMATION

CAT NR.	ORD NR.	LENGTH (END TO END)		THREADS	BOX QTY.
		(INCH)	(MM)		
HOSE WITH SWIVEL					
GHC-12/SW/B	43685	12	300	1/8" BSPT	250
GHC-18/SW/B	43688	18	450	1/8" BSPT	250
GHC-12/SW/M	43686	12	300	M10 x 1	250
GHC-18/SW/M	43689	18	450	M10 x 1	250
GHC-12/SW/N	43687	12	300	1/8" NPT	250
GHC-18/SW/N	43690	18	450	1/8" NPT	250

Superior Construction – Inner tubing is polyamide with polyurethane sheathing, reinforced diagonally in highly tear resistant polyester

- Inner diameter (d1): 0.16" (4.1 mm)
- Outer diameter (d2): 0.425" (11 mm)

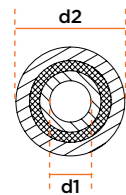

Large inner diameter makes them ideal for use in cold weather

Heavy duty zinc plated end connections hydraulically crimped to the hose

Rolled threads for extra strength

Also available

- Hose fitted with heavy-duty spring guard. Used primarily with Grease Control Valves
- Hose fitted with professional 4 jaw coupler with ball check



Standard Grease Hose

Hose With Professional 4 Jaw Coupler

Hose With Spring Guard

Hose fitted with Professional 4 Jaw Coupler with Ball Check

Hose fitted with heavy-duty spring guard. Used primarily with grease control valves

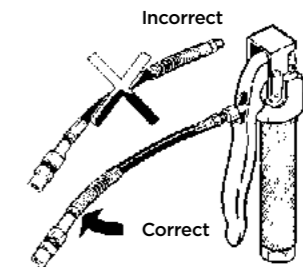

USEFUL TIPS!

Always buy a good quality hose. Accidents caused by poor quality hose can cause fatal injury

Other lengths can be custom manufactured

WARNING

Never use beyond recommended working pressure

FEATURES

WORKING PRESSURE

UPTO 5,800 PSI (400 BAR)

BURST PRESSURE

MIN. 13,775 PSI (950 BAR)

FOR USE WITH HAND & AIR OPERATED GREASE GUNS

ORDERING INFORMATION

CAT NR.	ORD NR.	LENGTH (END TO END)		THREADS	BOX QTY.
		(INCH)	(MM)		
STANDARD GREASE HOSE					
* GHC/HP-12/B	43700	12	300	1/8" BSPT	300
* GHC/HP-18/B	43701	18	450	1/8" BSPT	200
GHC/HP-20/B	43702	20	500	1/8" BSPT	200
* GHC/HP-12/M	43710	12	300	M10 x 1	300
* GHC/HP-18/M	43711	18	450	M10 x 1	200
* GHC/HP-20/M	43712	20	500	M10 x 1	200
GHC/HP-12/N	43720	12	300	1/8" NPT	300
* GHC/HP-18/N	43721	18	450	1/8" NPT	200
* GHC/HP-20/N	43722	20	500	1/8" NPT	200

* Best Seller

ORDERING INFORMATION

CAT NR.	ORD NR.	LENGTH (END TO END)		THREADS	BOX QTY.
		(INCH)	(MM)		
HOSE WITH PROFESSIONAL 4 JAW COUPLER					
* GHC/HP-12/HC/14/4/B	43730	12	300	1/8" BSPT	250
* GHC/HP-18/HC/14/4/B	43731	18	450	1/8" BSPT	250
* GHC/HP-12/HC/14/4/M	43740	12	300	M10 x 1	250
* GHC/HP-18/HC/14/4/M	43741	18	450	M10 x 1	250
* GHC/HP-12/HC/14/4/N	43750	12	300	1/8" NPT	250
* GHC/HP-18/HC/14/4/N	43751	18	450	1/8" NPT	250

* Best Seller

ORDERING INFORMATION

CAT NR.	ORD NR.	LENGTH (END TO END)		THREADS	BOX QTY.
		(INCH)	(MM)		
HOSE WITH SPRING GUARD					
GHC/HP-12/SPR/B	43760	12	300	1/8" BSPT	200
GHC/HP-18/SPR/B	43761	18	450	1/8" BSPT	200
GHC/HP-12/SPR/M	43770	12	300	M10 x 1	200
GHC/HP-18/SPR/M	43771	18	450	M10 x 1	200
* GHC/HP-12/SPR/N	43780	12	300	1/8" NPT	200
* GHC/HP-18/SPR/N	43781	18	450	1/8" NPT	200

* Best Seller

58

Grease Gun Light

Now it easy to locate grease fittings in dark areas, shoulders & other difficult to locate points

Slim construction with a powerful LED

Fits both grease gun steel extensions & flexible hoses with ease

Includes 3 LR 41 button cells

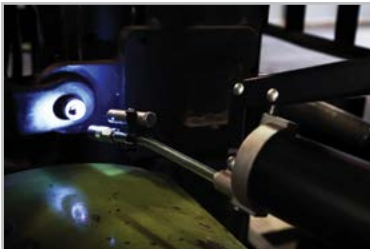

ORDERING INFORMATION

CAT NR.	ORD NR.	BOX QTY.
LED/GGL/01	55015	500

59

Air Bleeder Valves

ARV

Spare bleeder valves for grease guns

Available in Manual & Automatic versions

Vents air pockets in grease guns efficiently

Zinc plated finish



Manual

Automatic

ORDERING INFORMATION

CAT NR.	ORD NR.	THREADS
MANUAL		
ARV/01/B	44839	1/8" BSPT
ARV/01/M	44837	M10 x 1
ARV/01/N	44838	1/8" NPT
AUTOMATIC		
SA/ARV/G70/B	44897	1/8" BSPT
SA/ARV/G70/M	44898	M10 x 1
SA/ARV/G70/N	44899	1/8" NPT

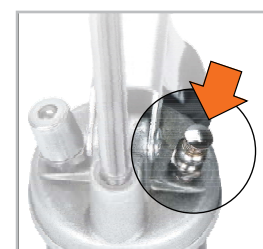

Manual Air Release valve

Press down to release trapped air in grease

Spare loader valves for bulk loading grease guns using filler pump

Built in ball check

Zinc plated finish

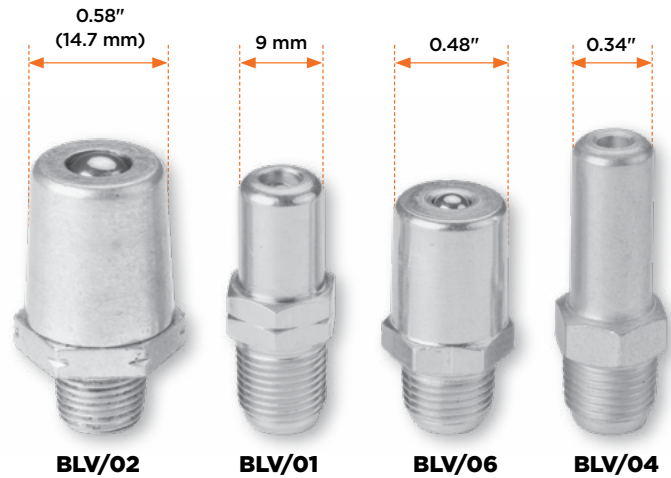

ORDERING INFORMATION

CAT NR.	ORD NR.	CAT NR.	ORD NR.	CAT NR.	ORD NR.	TYPE
1/8" BSPT		M10 x 1		1/8" NPT		
BLV/01/B	44830	BLV/01/M	44833	BLV/04/N	44835	Straight
BLV/02/B	44831	-	-	BLV/02/N	44834	Tapered
-	-	-	-	BLV/06/N	44836	Tapered

Used on GROZ Grease Guns as standard



Grease Gun extension swivel threaded 1/8" Male x 1/8" Female

Female end of the swivel fits onto the Grease Gun extension & male end onto the Grease Gun coupler, enabling unrestricted movement without any bending, twisting or kink

All steel construction in plated finish



FEATURES

WORKING PRESSURE  UPTO 3,500 PSI (240 BAR)	USE WITH HAND OPERATED GREASE GUNS 
---	--

ORDERING INFORMATION

CAT NR.	ORD NR.	THREADS	BOX QTY.
SWV/1-8M/1-8F/B	44885	1/8" BSPT	500
SWV/1-8M/1-8F/M	44886	M10 x 1	500
SWV/1-8M/1-8F/N	44887	1/8" NPT	500

62

Grease Gun Swivel - High Pressure

SWV-HP

Grease Gun extension swivel threaded 1/8" Male x 1/8" Female

All steel heavy duty construction: can withstand high pressure applications with ease

Hexagonal nut allows easy tightening

Female end of the swivel fits onto the Grease Gun extension & male end onto the Grease Gun outlet, enabling unrestricted movement without any bending, twisting or kink

FEATURES

PRESSURE	
	UPTO 10,000 PSI (690 BAR)
FOR USE WITH HAND, AIR & BATTERY OPERATED GREASE GUNS	

NEW!



ORDERING INFORMATION

CAT NR.	ORD NR.	THREADS
SWV/HP/1-8M/1-8F/B	44874	1/8" BSPT
SWV/HP/1-8M/1-8F/M	44883	M10 x 1
SWV/HP/1-8M/1-8F/N	44884	1/8" NPT



Without Swivel - Twisting of hose



With Swivel - No Twisting of hose

63

360° Slim Line Swivel Coupler

HC-SW

Designed for convenient access into narrow, inaccessible greasing joints

Hardened coupler body & swivel joints withstand high-pressure applications without deformation

Swivels in full 360° circle & locks conveniently at any 45° position. 45° angle gives easy access to most grease fittings

Spring steel jaws are fully hardened for extended service life

Spring loaded ball check valve helps retain pressure

Zinc plated finish

FEATURES

PRESSURE	
	UPTO 3,000 PSI (207 BAR)
USE WITH HAND OPERATED GREASE GUNS	
4 JAW CONSTRUCTION	WITHOUT BALL CHECK

NEW!



ORDERING INFORMATION

CAT NR.	ORD NR.	THREADS
HC/SW/11/4/B	43533	1/8" BSPT
HC/SW/11/4/M	43534	M10 x 1
HC/SW/11/4/N	43538	1/8" NPT



Convenient access into narrow, inaccessible greasing joints



Rugged steel Bearing Packers

Useful for greasing bearings in cars, boats, tractors, RV's etc

BEP-625

- Rapid action Bench Type Bearing Packer
- Non threaded top cone for fast placement of bearings
- Design incorporates grease nipple on the outer shaft, which easily adapts to the grease gun coupler
- Suited for bearings with a min. inner diameter of 1/2" (12 mm), to a max. outer diameter of 6" (150 mm) and height from 3/8" (10 mm) to 2" (50 mm)
- For use with standard grease guns



BEP-01

- Bearing Packer with threaded center post
- Design incorporates grease nipple at one end, which easily adapts to the grease gun coupler.
- Suited for bearings with a min. inner diameter of 1/2" (12 mm), to a max. outer diameter of 5" (125 mm) and height from 1/4" (6 mm) to 2" (50 mm)
- For use with standard grease guns



BEP/625/WB

- Rapid Action Bearing Packer
- Non threaded top cone for fast placement of bearings
- Outer shaft is threaded 1/4" NPT (F) & fits onto the Outlet Discharge Tube of the Grease Filler Pump
- Suited for bearings with a min. inner diameter of 1/2" (12 mm), to a max. outer diameter of 6" (150 mm) and height from 3/8" (10 mm) to 2" (50 mm)
- For use with grease gun filler pumps



USEFUL TIPS!

Always use recommended grade of grease. Some grades of grease cannot handle temperatures of wheel bearing applications

Do not use compressed air for cleaning the bearing prior to use with the bearing packer. This is unsafe and could damage the race

ORDERING INFORMATION

CAT NR.	ORD NR.	DESCRIPTION	BOX QTY.
BEP/01	44845	For use with grease guns	30
BEP/625	44847	For use with grease guns	12
BEP/625WB	44848	For use with filler pump	12



G77

Convenience of a Pistol Grip with Power of a Lever Handle

2 Way Operating Telescopic Handle

Press lever to switch between

Pistol type: ideal for use in confined spaces

Lever type: for high pressure & high volume application

Dual Discharge Ports

Front port for use in pistol mode & top port for use in lever mode

Multifunction Grease Gun

Integrated high volume – high pressure adjustable mechanism Shift between high volume & high pressure greasing

1. Lift the button to unlock
2. Slide to change mode
3. Press button to lock back in position

Built Tough

- Aluminum die cast head fitted with bulk loader & air bleeder valve
- Barrel with 0.049" (1.2 mm) wall thickness
- Heavy duty follower spring
- Non-slip comfortable vinyl grip
- Rolled threads for quick & easy re-loading

For use with 400 gm (14 oz.) Grease cartridge or 500 cc Bulk Fill

Suitable for use with NLGI 1, 2, 3 greases

HIGH PRESSURE SETTING

Lever Style

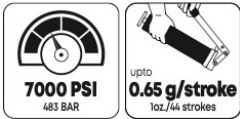

Pistol Style

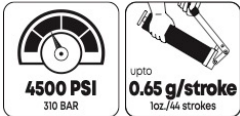

HIGH VOLUME SETTING

Lever Style



Pistol Style N.A

FILLING OPTIONS

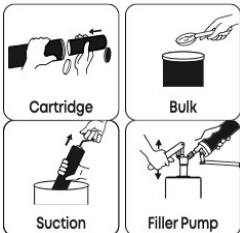

Ordering Information

CAT NR.	ORD NR.	THREADS
G77RF-18/B	42380	1/8" BSPT
G77RF-18/M	42381	M10 X 1
G77RF-18/N	42382	1/8" NPT

PISTOL GRIP GREASE GUN - 'V' SERIES V5

Product Brief

Value Priced One Hand Operated Pistol Grip Grease Gun

Aluminium Die Cast head fitted with air release valve

Hi-visibility orange powder coated finish

Develops

5,000 PSI / 345 BAR

Capacity

14 oz. (400 gms) grease cartridge or 500 cc bulk

Complete with a choice of 4" (100 mm) steel extension or 12" (300 mm) flexible hose & standard 4 jaw coupler with ball check



CAT. NR.	ORD. NR.	CAT. NR.	ORD. NR.	CARTRIDGE CAPACITY	BULK CAPACITY	THREADS
WITH STEEL EXTENSION & COUPLER		WITH FLEXIBLE HOSE & COUPLER				
V5R/B	42950	V5F/B	42970	14 oz (400 gms)	500cm ³	1/8" BSPT
V5R/M	42951	V5F/M	42971	14 oz (400 gms)	500cm ³	M10 x 1
V5R/N	42952	V5F/N	42972	14 oz (400 gms)	500cm ³	1/8" NPT

MINI PISTOL GREASE GUN MARINE

Product Brief



One hand pistol grip grease gun designed for trouble-free use in corrosive environments

Lightweight and non-corroding aluminium barrel in premium powder coated finish

Stainless steel (SS-304) handle, end cap and connecting link

Choice of materials makes this an ideal tool for use in marine applications

Complete with 4" (100 mm) steel extension and coupler

FILLING OPTION



CAT NR.	ORD NR.	CARTRIDGE CAPACITY		THREADS
		(OZ.)	(GMS)	
G-16/MR/B	43240	3	85	1/8" BSPT
G-16/MR/M	43241	3	85	M10 × 1
G-16/MR/N	43242	3	85	1/8" NPT

Product Brief

Designed for unmatched versatility, superior performance and maximum value this is an ideal tool for everyday greasing and maintenance jobs

Builds upto 10,000 PSI (690 BAR)

Clears clogged and jammed fittings with ease

2 Speed Design

- a. Standard Flow
- b. High Flow

2000 mAh, 18.5V Lithium-ion Battery

Powers the 20V high torque motor

Fully charged battery dispenses upto 12 cartridges*

***in free flow condition**



DELIVERS	MAXIMUM PRESSURE	BATTERY CHARGE TIME
UPTO 3 OZ. (85 GMS) / MINUTE	 10,000 PSI (690 BAR)	1 HOUR

What's included

1. Grease Gun Assembly
2. Grease Gun Hose with Coupler
3. Shoulder Strap
4. Quick Battery Charger
5. Lithium-ion Battery (1)
6. Blow Moulded Case

LOADING OPTIONS

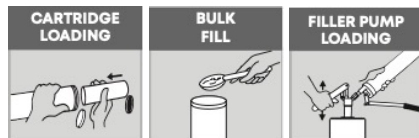

****Peak Voltage**

CAT. NR.	DESCRIPTION	BOX QTY.
RB/CGG/2000	Rechargeable Battery 2000 mAh Li-ion	3
BC/CGG/20L/US	1 hour Battery Charger, 110V/60Hz, 20V**, US Plug	3
BC/CGG/20L/EU	1 hour Battery Charger, 220V/50Hz, 20V**, EU Plug	3
BC/CGG/20L/UK	11 hour Battery Charger, 220V/50Hz, 20V**, UK Plug	3
HOS/BG/40/N	40" (1000mm) replacement hose	3

CAT NR.	DESCRIPTION	BOX QTY.
CGG/20L1/US	14 OZ. GREASE GUN, 1PC LI-ION BATTERY, US PLUG	3
CGG/20L1/EU	14 OZ. GREASE GUN, 1PC LI-ION BATTERY, EU PLUG	3
CGG/20L1/UK	14 OZ. GREASE GUN, 1PC LI-ION BATTERY, UK PLUG	3
*THEORETICAL REFERENCE VALUES		CALCULATED BY COUNTING PISTON STROKES

HANDY BEARING PACKER

Product Brief

Light-weight and handy, portable Bearing Packer

Mess and hassle free solution for quick removal of old grease and replacement with new grease

Designed for use on bearings with:

- Minimum dia. of 1-3/4" (45mm)
- Maximum dia. 3-1/2" (89 mm)

Using the handy bearing packer

Simple hand press mechanism eliminates the need for any grease gun or pump to grease the bearing

Useful for greasing bearings in cars, boats, tractors, RV's etc

USEFUL TIPS!

Always use recommended grade of grease. Some grades of grease cannot handle temperature of wheel bearing applications

Do not use compressed air for cleaning the bearing prior to use with the bearing packer. This is unsafe and could damage the race



CAT NR.

ORD NR.

BEP/10

44940

GREASING ACCESSORY KIT - E SERIES

Product Brief

Grease Gun Accessories for everyday lubrication in garages, workshops, construction sites, agricultural and marine applications

Kit consist of common greasing attachments that fit most grease guns, hydraulic couplers, grease pumps and other grease dispensing equipment

Constituents safely stored in a heavy-duty blow moulded, easy to carry case



CAT NR.	ORD NR.	THREADS
GAK/E1/11ST/B	44964	1/8" BSPT
GAK/E1/11ST/M	44963	M10 %uFFFFD 1
GAK/E1/11ST/N	44962	1/8" NPT

Product Brief

Grease Gun Accessories, engineered to withstand rugged use in garages, workshops, construction sites, agricultural and marine applications

Versatile kit consist of professional use greasing attachments that fit most grease guns, hydraulic couplers, grease pumps and other grease dispensing equipment

Constituents safely stored in a heavy-duty blow moulded, easy to carry case



CAT NR.	ORD NR.	THREADS
GAK/P1/8ST/B	44961	1/8" BSPT
GAK/P1/8ST/M	44960	M10 %UFFFD 1
GAK/P1/8ST/N	44959	1/8" NPT

По вопросам продаж и поддержки обращайтесь:

Алматы (7273)495-231
Архангельск (8182)63-90-72
Астрахань (8512)99-46-04
Барнаул (3852)73-04-60
Белгород (4722)40-23-64
Брянск (4832)59-03-52
Владивосток (423)249-28-31
Волгоград (844)278-03-48
Вологда (8172)26-41-59
Воронеж (473)204-51-73
Екатеринбург (343)384-55-89
Иваново (4932)77-34-06
Ижевск (3412)26-03-58
Иркутск (395)279-98-46
Россия (495)268-04-70

Казань (843)206-01-48
Калининград (4012)72-03-81
Калуга (4842)92-23-67
Кемерово (3842)65-04-62
Киров (8332)68-02-04
Краснодар (861)203-40-90
Красноярск (391)204-63-61
Курск (4712)77-13-04
Липецк (4742)52-20-81
Магнитогорск (3519)55-03-13
Москва (495)268-04-70
Мурманск (8152)59-64-93
Набережные Челны (8552)20-53-41
Нижний Новгород (831)429-08-12
Киргизия (996)312-96-26-47

Новокузнецк (3843)20-46-81
Новосибирск (383)227-86-73
Омск (3812)21-46-40
Орел (4862)44-53-42
Оренбург (3532)37-68-04
Пенза (8412)22-31-16
Пермь (342)205-81-47
Ростов-на-Дону (863)308-18-15
Рязань (4912)46-61-64
Самара (846)206-03-16
Санкт-Петербург (812)309-46-40
Саратов (845)249-38-78
Севастополь (8692)22-31-93
Симферополь (3652)67-13-56
Казахстан (7172)727-132

Смоленск (4812)29-41-54
Сочи (862)225-72-31
Ставрополь (8652)20-65-13
Сургут (3462)77-98-35
Тверь (4822)63-31-35
Томск (3822)98-41-53
Тула (4872)74-02-29
Тюмень (3452)66-21-18
Ульяновск (8422)24-23-59
Уфа (347)229-48-12
Хабаровск (4212)92-98-04
Челябинск (351)202-03-61
Череповец (8202)49-02-64
Ярославль (4852)69-52-93